



# Product Catalog



Designed and Fabricated in Melbourne, FL U.S.A. 

[ZahBuilt.com](http://ZahBuilt.com)

A photograph of a man and a woman sitting at a dining table. The man is pouring wine from a green bottle into a glass held by the woman. They are both smiling. The table is set with white dishes, glasses of wine, and a green napkin. The background is a bright, outdoor setting with greenery.

Reimagining The Way We Live



# Table of Contents

	SPECIFICATIONS	5
	DOOR STYLES	10
	FINISHES	23
	GRILL BASE CABINETS	27
	CERAMIC GRILL CABINETS	33
	BASE CABINETS	37
	WALL CABINETS	47
	TALL CABINETS	50
	PANELS, FILLERS & ACCESSORIES	52
	WINDSWEPT MOLDINGS	67
	HOODS	73





# Specifications

*Windswept Collection / Storm*



# Cabinet Construction Specifications

## **CABINET BOX**

Cabinet sides, top and bottom are constructed with a 3/4" thick, lightweight HDPE (HDPE) poly marine board that is UV stable. It is NOT PVC.

All of the components are assembled with hidden polymer. These fasteners are made from high strength plastic and CNC machined into the cabinet parts.

## **EDGEBANDING**

There is no edgelanding, the HDPE is solid black and all cabinet edges are black. The full overlay door covers all but 1/8" of the edge. This also eliminates possible edgelanding point of failure.

## **CABINET BACK**

All cabinets have a 1/4" thick (HDPE) back with 4" nailers top and bottom.

## **SHELVES**

Shelves are 3/4" thick HDPE. There are shelf holes drilled in 32mm (1 1/4") increments. All shelves are full depth. Shelves over 28" wide will have lineal support front and back.

## **DRAWER BOXES**

Standard drawer boxes are constructed with 3/4" HDPE sides and back with a 1/4" thick bottom and assembled with panel connector. Full extension soft-close bottom mount slides are treated for corrosion.

## **DOOR HINGES**

Hinges are soft-close stainless steel 110° concealed hinges with 6 way adjustment.

## **FINISHED ENDS**

Finished ends can be purchased loose. Finished end panels are the thickness of the species panel, which adds to the overall width of a cabinet.

## **TOE KICK**

All base and tall cabinets are constructed on adjustable leg levelers. 3 1/2" to 5" high. Additional height levelers and spacers available.



# Cabinet Standards

## GENERAL SPECIFICATIONS

We manufacture our cabinet boxes using 3/4" Black HDPE (Low Density Polyurethane). HDPE is UV stable.

## CABINET SIZES

Available in sizes listed only. To change the depth of a cabinet to 24" or 28", modification charges will apply. See modification section for up-charges. Modifications limited to the nearest inch.

## MINIMUM CABINET WIDTH

With doors: 9" W based on the minimum width of available door styles. With drawers: 12" W

## MAXIMUM CABINET WIDTH

To be warrantied, the maximum width of a specific cabinet type is the width listed as the largest available.

## MINIMUM HEIGHT

With doors: 12" H

## MAXIMUM HEIGHT

90 1/2"

## STANDARD CABINET DEPTHS *(Defaults)*

Wall cabinets: 13" D  
Base cabinets: 24" or 28" D  
Grill base cabinets: 28" D  
Burner base cabinets: 28" D  
Wall depth base cabinets: 13" D  
Base depth tall cabinets: 24" D

## MAXIMUM DEPTH

36" D. When the depth is increased for cabinets with drawers and/or roll out drawers, the drawer box depth remains 21" regardless of cabinet depth.

## FINISHED ENDS

ZähBuilt provides finished ends as an applied panel, subject to additional up-charges. Integrated finished end available in Sonoma collection per request.

## TOE KICK

ZähBuilt provides plastic leg levelers that are adjustable from 3 1/2" H to 4-1/2" H. We also offer door matching toe kick planks



# General Knowledge

## GENERAL INSTALLATION GUIDELINES

- It is very important the cabinetry is installed level and plumb. This will ensure the doors hang properly. The fronts are set squarely at the factory. If the cabinet is not level, the doors are drawers will be skewed. Only after leveling should the doors be adjusted.
- To adjust the floor levelers, we recommend the use of the Hafele leveler tool (PN # 637.76.430) for easy access, available from ZähBuilt or Hafele direct.
- Use stainless steel screws and washers for installation hardware.
- Grill panels may be removed in order to trim and fit to the grill. The countertop thickness will determine the depth of the cut. Reattach the trimmed grill panel using button fix.
- The door adjustments are accessible by removing the cover plate on the hinge arm.
- There is a small amount of adjustment available on the drawer by using the dials on the drawer box clips.

## CABINETS AND PARTS

- The HDPE cabinet parts saw and machines similar to MDF with smooth, non-splintered, chip free cuts.
- Cleans with soap and water. Use denatured alcohol or non oil based cleaners for greasy spots.
- All cabinet backs are 1/4" HDPE with 4" nailers top and bottom.
- We recommend 1-1/4" stainless steel washer head screws for joining cabinets and fillers, etc.
- Bases come with adjustable leg levelers, making installation easy on sloped floors.
- The toe plates are held in place with a friction clip on the leveler, additional screws could be used as necessary.

## GRILL ACCOMMODATIONS

- An insulation jacket is required for gas grill cabinets.
- The cabinet needs to be minimum 3" wider than grill insulation jacket, preferably 6" + (must be 6" wider for NEO collection).

# Working With Our Sonoma HPL Panels

## SAWING

- Sonoma panels can be cut on stationary circular saws, portable circular saws or jig saws using carbide tipped blades.
- We recommend alternating bevel fine cutting blades.
- Cutting too fast or too slow can result in surface discoloration. The discolored surface can be sanded off using 180 - 220 grit sandpaper.

## FINISHING

- Cut edges are dangerously sharp and need to be eased. We recommend routing the edges or breaking the edge with sand paper.
- Teak or mineral oil can be used to polish the edges and add a layer of protection.

## DRILLING

- Use high-speed steel drill bits.

## ATTACHING

- Stainless steel screws offer the most secure way of attaching Sonoma panels/fillers/overlay doors to our cabinetry.
- Carefully drill a pilot hole first. Stainless steel self tapping screws are a good option as Sonoma panels produce a fine thread and can be tapped.
- VHB tape is a good alternative for panels resting on a solid surface or to hold panels until the adhesive sets.





# Door Styles

---

# Windswept Cumulus / Louver Door

## Specifications

### COLLECTION

Windswept

### CONSTRUCTION

1" thick Stiles & Rails, 5/8" Panel

### RAIL WIDTH

2 3/4"

### MINIMUM/MAXIMUM

#### DOOR WIDTH

12" / 24"

### MINIMUM/MAXIMUM

#### DOOR HEIGHT

12" / 60"

### DRAWER FRONTS

The top drawer face is always a 7" high slab drawer fronts over 8" can be ordered in a stile and rail configuration for an additional cost

### FINISHED BACK OF DOOR

Painted Base Color only, no glaze

## EDGE PROFILES



*Finish / Sand*

The center louver is accomplished by stacking 6" wide T & G moldings. The moldings "float" between the stiles and rails utilizing our patent design. This method of assembly mitigates movement that may split the frame or damage the paint.

# Windswept Virga / Shaker Door

## Specifications

### COLLECTION

Windswept

### CONSTRUCTION

1" thick Stiles & Rails, 5/8" Panel

### RAIL WIDTH

2 3/4"

### MINIMUM/MAXIMUM

#### DOOR WIDTH

12" / 24"

### MINIMUM/MAXIMUM

#### DOOR HEIGHT

12" / 60"

### DRAWER FRONTS

The top drawer face is always a 7" high SLAB.drawer fronts over 8" can be ordered in a stile and rail configuration for an additional cost

### FINISHED BACK OF DOOR

Painted Base Color only, no glaze

The center panel is "floating" between the stiles and rails utilizing our patent design. This method of assembly mitigates movement that may split the frame or damage the paint.

## EDGE PROFILES



*Finish / Storm*

# Windswept Anvil / Slab Door

## Specifications

**COLLECTION**  
Windswept

**CONSTRUCTION**  
Slab

**MINIMUM/MAXIMUM  
DOOR WIDTH**  
12" - 24"

**MINIMUM/MAXIMUM  
DOOR HEIGHT**  
12" / 60"

**DRAWER FRONTS**  
1" thick slab with integral edge detail

**GRAIN DIRECTION, DOOR**  
Grain direction is vertical on doors,  
horizontal grain not available

**GRAIN DIRECTION, DRAWER**  
Grain direction is horizontal on  
drawers, vertical grain not available

**FINISHED BACK OF DOOR**  
Painted base color only, no glaze

## EDGE PROFILES



*Finish / Cyclone*

# Windswept Cirrus / Skinny Shaker Door

## Specifications

### COLLECTION

Windswept

### CONSTRUCTION

Accoya trim with an eased edge wrapping a veneered composite panel

### MINIMUM/MAXIMUM

#### DOOR WIDTH

9" / 21"

### MINIMUM/MAXIMUM

#### DOOR HEIGHT

12" / 60"

### DRAWER FRONTS

Match door construction

### GRAIN DIRECTION, DOOR

Grain direction is vertical by default.

### GRAIN DIRECTION, DRAWER

Grain direction is horizontal by default.

### FINISHED BACK OF DOOR

Same finish as the front

### DOOR STYLE FACTOR

Factor is 10% and upgrade

Cirrus

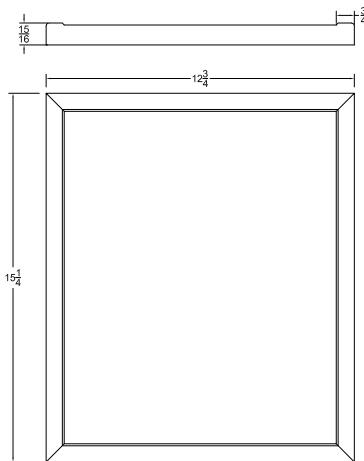

Finish / Wheatland

# Windswept Stratus / Pillow Door

## Specifications

### COLLECTION

Windswept

### CONSTRUCTION

Slab with 1-1/16" sloped edge

### MINIMUM/MAXIMUM

#### DOOR WIDTH

9" / 21"

### MINIMUM/MAXIMUM

#### DOOR HEIGHT

12" / 60"

### DRAWER FRONTS

Match door construction

### GRAIN DIRECTION, DOOR

Grain direction is vertical by default.

### GRAIN DIRECTION, DRAWER

Grain direction is horizontal by default.

### FINISHED BACK OF DOOR

Same finish as the front

### DOOR STYLE FACTOR

Factor is 10%

## Stratus

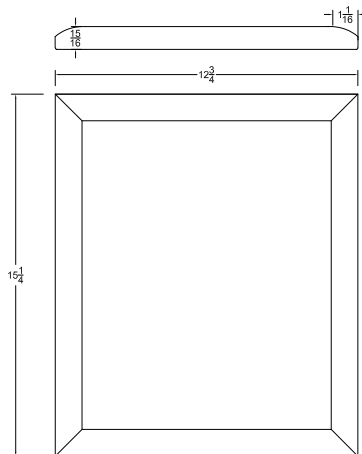

*Finish / Riptide Blue*

# Windswept Alto / Mitered Bolection

## Specifications

### COLLECTION

Windswept

### CONSTRUCTION

1" thick Stiles & Rails, 5/8" Panel

### RAIL WIDTH

2 3/4"

### MINIMUM/MAXIMUM

#### DOOR WIDTH

12" / 24"

### MINIMUM/MAXIMUM

#### DOOR HEIGHT

12" / 60"

### DRAWER FRONTS

The top drawer face is always a 7" high SLAB.drawer fronts over 8" can be ordered in a stile and rail configuration for an additional cost

### FINISHED BACK OF DOOR

Painted Base Color only, no glaze

## EDGE PROFILES



*Finish / Paracas*

The center panel is "floating" between the stiles and rails utilizing our patent design. This method of assembly mitigates movement that may split the frame or damage the paint.

# Windswept Aurora / Mitered Shaker

## Specifications

### COLLECTION

Windswept

### CONSTRUCTION

1" thick Stiles & Rails, 5/8" Panel

### RAIL WIDTH

2 3/4"

### MINIMUM/MAXIMUM

#### DOOR WIDTH

12" / 24"

### MINIMUM/MAXIMUM

#### DOOR HEIGHT

12" / 60"

### DRAWER FRONTS

The top drawer face is always a 7" high SLAB.drawer fronts over 8" can be ordered in a stile and rail configuration for an additional cost

### FINISHED BACK OF DOOR

Painted Base Color only, no glaze

## EDGE PROFILES



*Finish / Riptide Blue*

The center panel is "floating" between the stiles and rails utilizing our patent design. This method of assembly mitigates movement that may split the frame or damage the paint.

# Windswept Ripcurl / J-Pull

## Specifications

### COLLECTION

Windswept

### CONSTRUCTION

Slab with 1-1/16" sloped edge

### MINIMUM/MAXIMUM

#### DOOR WIDTH

9" / 21"

### MINIMUM/MAXIMUM

#### DOOR HEIGHT

12" / 60"

### DRAWER FRONTS

Match door construction

### GRAIN DIRECTION, DOOR

Grain direction is vertical by default.

### GRAIN DIRECTION, DRAWER

Grain direction is horizontal by default.

### FINISHED BACK OF DOOR

Same finish as the front

### DOOR STYLE FACTOR

Factor is 10%



*Finish / Overcast*

# Sonoma Slab Door

## Specifications

### COLLECTION

Sonoma

### CONSTRUCTION

5/8" Sonoma (phenolic resin) door with micro chamfer with an ebony colored polished edge

### MINIMUM/MAXIMUM

#### DOOR WIDTH

9" / 21"

### MINIMUM/MAXIMUM

#### DOOR HEIGHT

12" / 60"

### DRAWER FRONTS

5/8" thick slab with micro chamfer edges

### GRAIN DIRECTION, DOOR

Grain direction is vertical by default.

### GRAIN DIRECTION, DRAWER

Grain direction is horizontal by default.

### FINISHED BACK OF DOOR

Same finish as the front

### DOOR STYLE FACTOR

Also applies to all panels and fillers

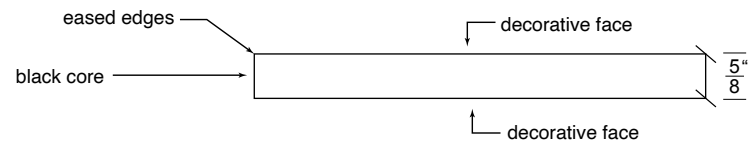

*Finish / Royal Walnut*

\*Sonoma Door / Drawer specifications continue on to the next page.



# Neo Door

## Specifications

### AVAILABLE

Brushed Aluminum finish or powder coated black available

### CONSTRUCTION

Aluminum with either a 1/4" thick Sonoma or 3/4" thick Accoya insert

### MINIMUM/MAXIMUM

#### DOOR WIDTH

12" / 24"

### MINIMUM/MAXIMUM

#### DOOR HEIGHT

12" / 60"

### GRAIN DIRECTION, DOOR

Grain direction is vertical on door panel

### GRAIN DIRECTION, DRAWER

Grain direction is horizontal on drawers, vertical grain not available

Top drawer is always 7" high

### FINISHED OPTIONS

Neo doors are available with all Windswept and Sonoma color selections

### FINISHED BACK OF DOOR

Windswept back will be base color only, Sonoma will be same as face

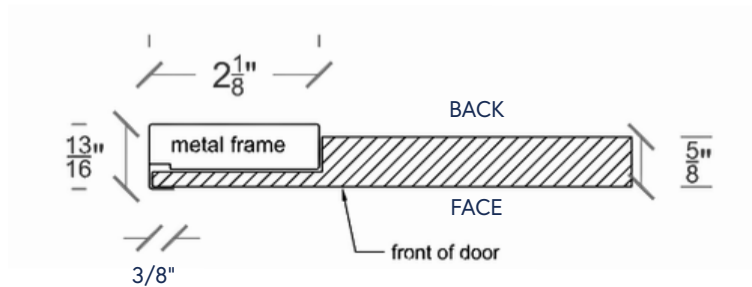

\*Sonoma Door / Drawer specifications continue on to the next page.



# Additional Neo Information

## CROSS SECTION

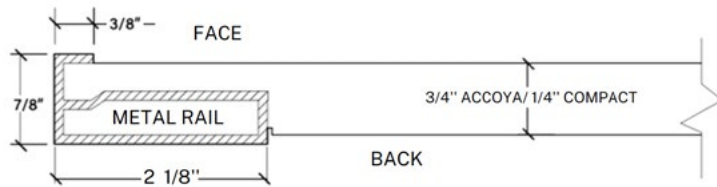

## NEO GRILL FRONTS

NEO Grill fronts will only have the Aluminum frame on the bottom and 2 sides to make it easier to install the insulated jacket.

Grill Cabinet must be a minimum of 6" wider than the Insulated Jacket.

# Opus/Slab Door *COMING SOON*

## Specifications

### COLLECTION

Opus

### CONSTRUCTION

3/4" One piece Composite Board  
WITH Eased EDGE

### MINIMUM/MAXIMUM

#### DOOR WIDTH

9"/24"

### MINIMUM/MAXIMUM

#### DOOR HEIGHT

12"/60"

### DRAWER FRONTS

3/4" One piece Composite Board  
WITH Eased EDGE

### GRAIN DIRECTION

Solid no grain Direction

### DESIGN CONSIDERATIONS

Doors painted solid color front and back. Only solid colors are available in this collection, with no glazed finishes.

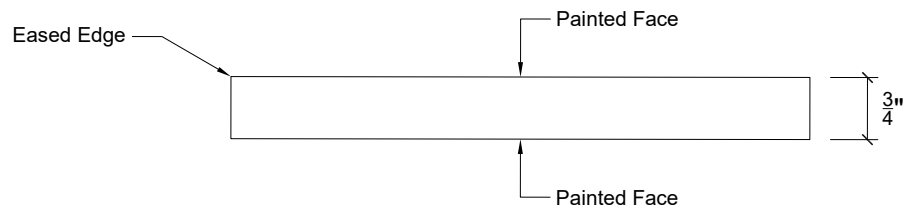

# Opus/Shaker Door COMING SOON

## Specifications

### COLLECTION

Opus

### CONSTRUCTION

3/4" One piece Composite Board  
1/4" Routed Center with  
1/4" Beveled inside  
profile and eased EDGE

### MINIMUM/MAXIMUM

#### DOOR WIDTH

9"/24"

### MINIMUM/MAXIMUM

#### DOOR HEIGHT

12"/60"

### DRAWER FRONTS

3/4" One piece Composite Board  
WITH Eased EDGE

### GRAIN DIRECTION

Solid no grain Direction

### DESIGN CONSIDERATIONS

Doors painted solid color front and  
back. Only solid colors are available in  
this collection, with no glazed finishes.

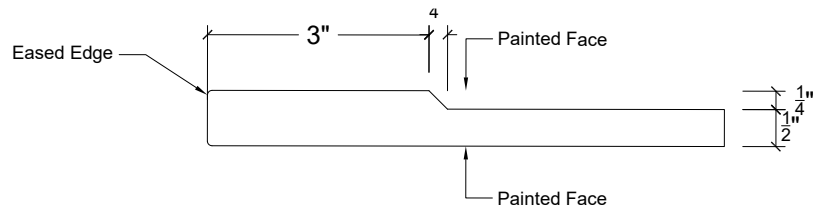



# Finishes

---

*Sonoma Collection / Noce Havana*

# Sonoma Finishes

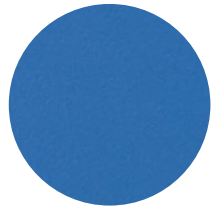

Spa



Sea White



Avalon Oak

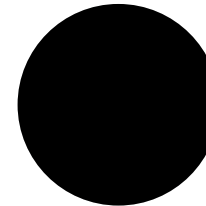

Cinder



Grey Cedar



Noce Havana

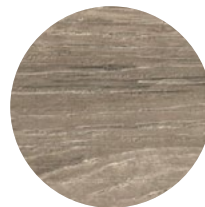

Riverside Oak



Royal Walnut



Polar White

## HOW IT'S MADE

Layers of sustainability harvested kraft paper are impregnated with thermosetting phenolic resins. The surface decorative finish layers are then applied on both sides and a transparent topcoat is added to the surface layers. This is cured to enhance weather and light protecting properties. The panels are then subject to high heat and pressure to bond the material into a non-porous, homogeneous material that is dense and perfect for outdoor surfaces like our cabinetry.

## DESIGN CONSIDERATIONS

Sonoma doors, drawers and panels are available in a sleek, ebony-polished edge, offering a clean, contemporary look. ZähBuilt has proprietary 5/8" (16mm) thick

# Windswept Door Finishes



Cyclone



Seaside



Sand



Sahara



Cocoa Bean



Wave Crest



Storm



Riptide Blue



Wheatland



Tempest

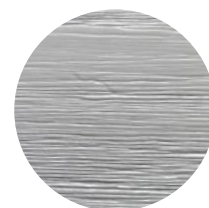

Overcast

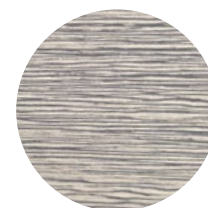

Tephra



Paracas

## DESIGN CONSIDERATIONS

Doors painted in White will come standard with a white door back, all other paint colors, stain and glaze or weathered finishes come standard with base color back, regardless of cabinet interior color.

# Custom Color Options

## Windswept Custom Color Program



### DESIGN CONSIDERATIONS

- Only available in solid colors, no glazes
- Standard selection of solid paint colors
- \$250 NET sample cost for approval is mandatory
- Add 2 weeks to lead time
- Approximate 10% cost increase over standard
- Windswept door cost

## Sonoma Custom Color Program



### DESIGN CONSIDERATIONS

- Ask your sales rep for current selections and lead time
- Add 8-12 weeks to lead time
- \$2,500 NET cost for custom color
- Approximate 15% cost increase over Sonoma door cost

321-308-3297 SALES@ZAHBUILT.COM ZAHBUILT.COM





# Grill Base Cabinets

*Windswept Collection / Cyclone*



# Grill Base Specifications

- Grill/side burner bases are available from 18" to 78" wide constructed from 3/4" black HDPE and assembled with dowels and strategic stainless steel screws
- Grill bases are 30 1/2" tall with 4" adjustable plastic leveler legs
- Grill bases have removable/trimmable "L" shaped risers to support the grill Insulated Jacket
- Grill base must be a minimum 3" wider than grill Insulated Jacket, preferably 6" + (must be 6" wider for NEO collection)
- Grill bases are 28" deep as a standard with ventilation grills in decks of cabinet.



HDPE risers are trimmed on site to provide the proper grill height. The stretcher and riser system allows air flow for proper ventilation. Place risers near to/above the partitions.

- All grills require an insulation jacket, generally this requires a base cabinet at least 6" wider than the grill
- All grill bases have a 12 1/2" high front that needs to be cut to accommodate the liner dimensions, the final height is determined by the countertop thickness (grill height minus countertop thickness = front cut out)
- Standard propane tanks will slide under the grill due to our patent pending aluminum drop down tray, this tray also provides a gas ventilation
- Cabinet edges are black



Optional Ventilation/propane tank clearance trays are installed into the bottom of all grill base and burner base cabinets in order to prevent potential gas build-up within the cabinets (Patent Pending).

# Standard Grill Base Cabinets

All Grill Base Cabinets available in 24" depth

## 2-DOOR



### SKU

- GB30-2
- GB36-2
- GB39-2
- GB42-2

### DESIGN CONSIDERATIONS

- Cabinet is 28" DEEP
- Front panel is 12 1/2" H
- Panel can be cut on site to fit individual grills
- Doors are 17 3/4" H

### PARTITION

- Cabinets 36" W and wider will have a centered vertical partition between the doors

## 3-DOORS



### SKU

- GB45-3
- GB48-3
- GB54-3
- GB60-3

### DESIGN CONSIDERATIONS

- Cabinet is 28" DEEP
- Front panel is 12 1/2" H
- Panel can be cut on site to fit individual grills
- Doors are 17 3/4" H

### PARTITION

- Cabinets 36" W and wider will have a centered vertical partition between the doors

## 4-DOORS



### SKU

- GB45-4
- GB48-4
- GB54-4
- GB60-4
- GB72-4
- GB78-4

### DESIGN CONSIDERATIONS

- Cabinet is 28" DEEP
- Front panel is 11 7/8" H
- Panel can be cut on site to fit individual grills
- Doors are 17 3/4" H

### PARTITION

- Cabinets will have a partition separating the doors

# XL Grill/Pellet Grill Base Cabinets

## 2-DOOR



**SKU**

- XLGB30-2
- XLGB36-2
- XLGB39-2
- XLGB42-2

### DESIGN CONSIDERATIONS

- Cabinet is 28" DEEP
- Front panel is 18" H
- Panel can be cut on site to fit individual grills
- Doors are 12 1/4" H

### PARTITION

- Cabinets 36" W and wider will have a centered vertical partition between the doors

## 3-DOORS



**SKU**

- XLGB45-3
- XLGB48-3
- XLGB54-3
- XLGB60-3

### DESIGN CONSIDERATIONS

- Cabinet is 28" DEEP
- Front panel is 18" H
- Panel can be cut on site to fit individual grills
- Doors are 12 1/4" H

### PARTITION

- Cabinets 36" W and wider will have a centered vertical partition between the doors

## 4-DOORS



**SKU**

- XLGB45-4
- XLGB48-4
- XLGB54-4
- XLGB60-4
- XLGB72-4
- XLGB78-4

### DESIGN CONSIDERATIONS

- Cabinet is 28" DEEP
- Front panel is 18" H
- Panel can be cut on site to fit individual grills
- Doors are 12 1/4" H

### PARTITION

- Cabinets will have a partition separating the doors

# Standard Grill Base Cabinets

4 DRAWERS



**SKU**

- GB30-4D GB54-4D
- GB36-4D GB60-4D
- GB39-4D GB72-4D
- GB42-4D GB78-4D
- GB45-4D
- GB48-4D

**DESIGN CONSIDERATIONS**

- Grill base is 28" deep
- Front panel is 12 1/2" high to be cut by installer
- Drawer fronts are 8 3/4" high
- Drawer fronts over 8" can be ordered in a stile and rail configuration for an additional cost

**PARTITION**

- There is a full depth partition separating the drawers

2 DRAWERS & 1 DOOR



**SKU**

- GBC30-(L,R) GBC30-(L,R)
- GBC36-(L,R) GBC36-(L,R)
- GBC39-(L,R) GBC39-(L,R)
- GBC42-(L,R) GBC42-(L,R)

**DESIGN CONSIDERATIONS**

- Grill base is 28" deep
- Front panel is 12 1/2" high to be cut by installer
- Drawer fronts are 8 3/4" high
- Drawer fronts over 8" can be ordered in a stile and rail configuration for an additional cost

**PARTITION**

- There is a full depth partition separating the drawers
- The 'R' or 'L' signify what side the drawers are on

2 DRAWERS & 2 DOOR



**SKU**

- GBC48 (L,R) GBC54-(L,R)
- GBC54-(L,R) GBC60-(L,R)
- GBC60-(L,R) GBC72-(L,R)
- GBC72-(L,R) GBC78-(L,R)
- GBC78-(L,R)
- GBC45-(L,R)

**DESIGN CONSIDERATIONS**

- Grill base is 28" deep
- Front panel is 12 1/2" high to be cut by installer
- Drawer fronts are 8 3/4" high
- Drawer fronts over 8" can be ordered in a stile and rail configuration for an additional cost

**PARTITION**

- There is a full depth partition separating the drawers
- The 'R' or 'L' signify what side the drawers are on

# Standard Grill Base Cabinets

1 DOOR /  
BURNER BASE



SKU

BB15  
BB18  
BB21  
BB24

## DESIGN CONSIDERATIONS

- Burner base is 28" deep
- Front panel is 12 1/2" high to be cut by installer
- Sonoma BB24 will have two doors due to weight limitations.

1 DRAWER/  
BURNER BASE



SKU

BB15-1D  
BB18-1D  
BB21-1D  
BB24-1D

## DESIGN CONSIDERATIONS

- Burner base is 28" deep
- Front panel is 12 1/2" high to be cut by installer
- Drawer front is 17 3/4" high
- Drawer box is 12" H x 20" D
- Drawer fronts over 8" can be ordered in a stile and rail configuration for an additional cost

WARMING  
DRAWER  
GRILL BASE



SKU

WMDGB30-WMDGB54

## DESIGN CONSIDERATIONS

- Standard 28" depth
- Depths available in 3" increments
- Available in 24" depth
- Grill Front is 12-1/2" high
- Bottom Panel is 17-3/4" High
- Reinforced Fixed Shelf
- Two Support Pieces shipped loose
- Full slab front to be cut-out by dealer



# Ceramic Grill Cabinets

---

*Sonoma Collection / Avalon Oak*



# Standard Grill Base Cabinets

## WINDSWEPT CERAMIC GRILL CABINETS



SKU

WCG34.5  
WCG30.5  
DOOR

### DESIGN CONSIDERATIONS

- End panels are 30" deep and 3" wide
- For suspended application, see Specialty low base
- Overall H is 34 1/2" or 30 1/2"
- Overall W is 36"

- Inside dimension is 30" wide
- There is a vertical center partition
- A non-combustible surface (stone) must be installed on the resting platform



SKU

WCGD34.5  
WCGD30.5  
DRAWER

### DESIGN CONSIDERATIONS

- End panels are 30" deep and 3" wide
- For suspended application, see Specialty low base
- Overall H is 34 1/2" or 30 1/2"
- Overall W is 36"

- Inside dimension is 30" wide
- There is a vertical center partition
- Drawer box is 10" high
- A non-combustible surface (stone) must be installed on the resting platform

# Standard Grill Base Cabinets

## SONOMA CERAMIC GRILL CABINETS



SKU

CCG34.5  
CCG30.5  
DOOR

### DESIGN CONSIDERATIONS

- End panels are 30" deep and 5/8" wide
- For suspended application, see Specialty low base
- Optional mitered matching front edges available

- Overall H is 34 1/2" or 30 1/2"
- Overall W is 36"
- Inside dimension is 34 3/4" wide
- There is a vertical center partition
- A non-combustible surface (stone) must be installed on the resting platform



SKU

CCGD34.5  
CCGD30.5  
DRAWER

### DESIGN CONSIDERATIONS

- End panels are 30" deep and 5/8" wide
- For suspended application, see Specialty low base
- Optional mitered matching front edges available
- Overall H is 34 1/2" or 30 1/2"

- Overall W is 36"
- Inside dimension is 34 3/4" wide
- There is a vertical center partition
- Drawer box is 10" high
- A non-combustible surface (stone) must be installed on the resting platform

# Bow Front Ceramic Grill Cabinets

## WINDSWEPT SUSPENDED BOW FRONT

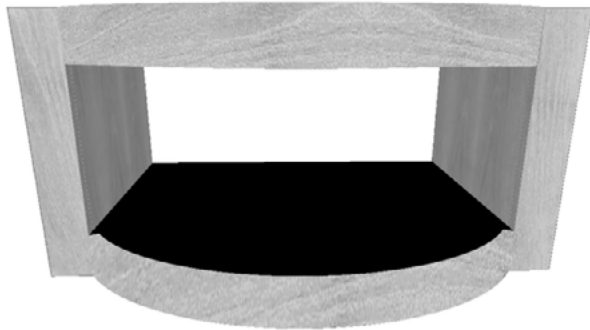

SKU

WSBF-20

### DESIGN CONSIDERATIONS

- End panels are 25" deep x 3" wide
- Overall height of suspended cabinet is 20", including 2 3/4" top and bottom rails
- Overall height of free standing unit is 34 1/4"
- Overall width is 36"
- Inside dimension is 30" wide
- Depth to end of radius is 34"
- Radius of arch is approx. 27" outside
- A non-combustible surface (stone) must be installed on the resting platform

## WINDSWEPT FREE STANDING BOW FRONT

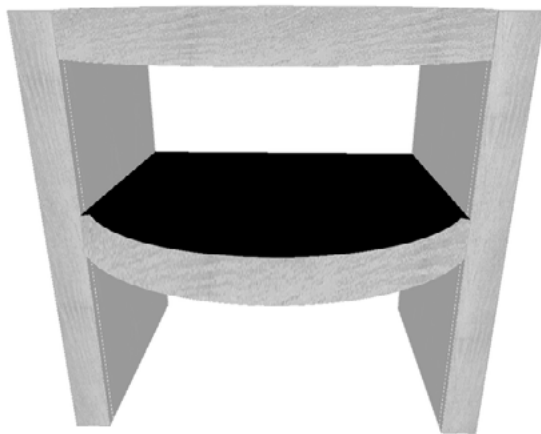

SKU

WFSBF- 34.5



# Base Cabinets

---

*Windswept Collection / Storm*



# Standard Base Cabinet Specifications

**All ZählerBuilt boxes are constructed from 3/4" black HDPE panels, making them weather resistant.**

- Assembled with Lockdowels
- Full Access, frameless construction
- Standard depth is 24" deep, can be ordered 28" deep.  
Drawers remain 21" deep
- 1/4" HDPE thick cabinet backs with 4" nailers top and bottom
- Full depth adjustable shelves
- 110° soft-close stainless steel concealed hinges
- Finished ends can be purchased loose
- Undermount full extension 21" slides, concealed by drawer sides and treated with corrosion blocker
- Drawer boxes are 3/4" HDPE with 1/4" bottoms.
- Standard base cabinets are 30 1/2" H plus an adjustable leg leveler (standard toe kick is 4")

# Standard Base Cabinet Specifications

## FULL HEIGHT DOOR



SKU

BFH12-BFH21

### DESIGN CONSIDERATIONS

- Width available in 1" increments
- 2 adjustable shelves
- Can be order 28" deep
- 'L' or 'R' signifies door hinge location

## 2 FULL HEIGHT DOORS



SKU

BFH24-2-BFH36-2

### DESIGN CONSIDERATIONS

- Width available in 1" increments
- 2 adjustable shelves
- Can be order 28" deep

## DRAWER OVER DOOR



SKU

B12-B21

### DESIGN CONSIDERATIONS

- Width available in 1" increments
- Top drawer face is 7" high slab
- Drawer box is 4" x 21" deep
- 1 adjustable shelf
- Can be ordered 28" deep, drawer box will remain 21" deep

## DRAWER OVER DOORS



SKU

B24-2-B36-2

### DESIGN CONSIDERATIONS

- Width available in 1" increments
- Top drawer face is 7" high slab
- Drawer box is 4" x 21" deep 1 adjustable shelf
- Can be ordered 28" deep, drawer box will remain 21" deep

# Drawer Base Cabinets

## 3 DRAWER



SKU

B3D12-36

### DESIGN SPECIFICATIONS

- 24" deep cabinet as standard 28" available
- Top drawer face is 7" high slab
- Top drawer box is 4" high
- Drawer Face 2 and 3 are 11 1/2" high
- Drawer Boxes 2 and 3 are 8" high
- Can be ordered 28" deep, drawer box will remain 21" deep
- Drawer fronts over 8" can be ordered in a stile and rail configuration for an additional cost

## ROLL OUTS

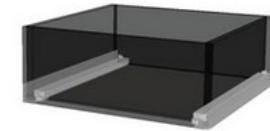
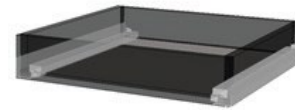

SKU

RO4  
RO8

### DESIGN SPECIFICATIONS

- 21" deep box
- 4" or 8" deep
- Full extension under mount slides
- Slides are behind front
- 1" spacer on sides

## 2 DRAWER



SKU

B2D12-36

### DESIGN SPECIFICATIONS

- 24" deep cabinet as standard 28" available
- Both Drawer faces are 15" high
- Both drawer boxes are 10" high
- Can be ordered 28" deep, drawer box will remain 21" deep
- Drawer fronts over 8" can be ordered in a stile and rail configuration for an additional cost

# Sink Base Cabinets

## 1 FULL HEIGHT DOOR



SKU

SBFH18 (L,R)  
SBFH21 (L,R)

## 2 FULL HEIGHT DOORS



SKU

SBFH24  
SBFH27  
SBFH30  
SBFH33  
SBFH36

### DESIGN CONSIDERATIONS

- (L,R) refers to door hinge location
- Width available in 1" increments

### SINK SKIRT

- 4" sink skirt including top stretcher

### PARTITIONS

- Sink cabinets have no interior partition (unless requested)

### SHELVES

- Sink cabinets have no shelves

## 1 DOOR FALSE FRONT



SKU

SBFF18 (L,R)  
SBFF21 (L,R)

## 2 DOOR FALSE FRONT



SKU

SBFF24  
SBFF27  
SBFF30  
SBFF33  
SBFF36

### DESIGN CONSIDERATIONS

- (L,R) refers to door hinge location
- Width available in 1" increments

### SINK SKIRT

- 8 1/4" sink skirt including top stretcher

### PARTITIONS

- Sink cabinets have no interior partition

### SHELVES

- Sink cabinets have no shelves
- 7" high slab FF

# Specialty Base Cabinets

## SPICE PULLOUT



**SKU**  
BSP9

### DESIGN CONSIDERATIONS

- Only available 9" wide
- 1 fixed shelf on center
- 2" lip on both sides of fixed shelves

## HANGING CUTLERY PULLOUT

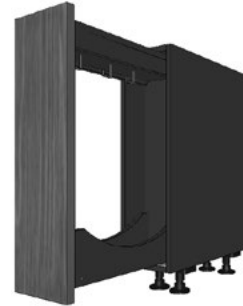

**SKU**  
BGA9

### DESIGN CONSIDERATIONS

- Only available 9" wide
- Approx. 26" clear inside height
- 5 stainless steel hanging hooks

## LOW HEIGHT BASE DOORS



**SKU**  
LBH24  
LBH30  
LBH36

### DESIGN CONSIDERATIONS

- Cabinet is 12" high plus 4" adjustable legs
- Has a center partition
- Can support a ceramic grill
- Standard is 24" deep

## LOW HEIGHT BASE DRAWERS

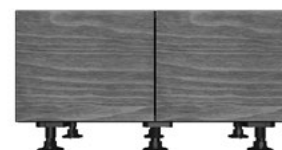

**SKU**  
LHBD24  
LHBD30  
LHBD36

### DESIGN CONSIDERATIONS

- Cabinet is 12" high plus 4" legs
- Drawers are 8" high
- Has a center partition
- Can support a ceramic grill
- Standard is 24" deep  
drawer fronts over 8" can be ordered in a stile and rail configuration for an additional cost

# Waste Bin Cabinets

## FULL HEIGHT WASTE BIN



**SKU**

FHWB12  
FHWB15  
FHWB18  
FHWB21

### DESIGN CONSIDERATIONS

- Trash bin not included. Available as an option.
- Cabinet has a 12" high roll out attached to the front allowing for a 26" high bin
- The 18" and 21" wide will accommodate 2 trash bins

## WASTE BIN WITH DRAWER



**SKU**

BWB12  
BWB15  
BWB18  
BWB21

### DESIGN CONSIDERATIONS

- Trash bin not included. Available as an option.
- Drawer front is 7" high
- Cabinet has as 12" high roll out attached to the front allowing for a 18" high bin
- The 18" and 21" wide will accommodate 2 trash bins

# Specialty Base Cabinets

## WALL DEPTH BASE CABINET 1 DOOR



SKU

WDB12-(12,15,18)  
WDB15-(12,15,18)  
WDB18-(12,15,18)  
WDB21-(12,15,18)

### DESIGN CONSIDERATIONS

- Please note 12", 15", or 18" depth
- Cabinet is 30 1/2" high plus 4" levelers
- 2 adjustable shelves

## WALL DEPTH BASE CABINET 2 DOOR



SKU

WDB24-(12,15,18)  
WDB27-(12,15,18)  
WDB30-(12,15,18)  
WDB33-(12,15,18)  
WDB36-(12,15,18)

### DESIGN CONSIDERATIONS

- Please note 12", 15", or 18" depth
- Cabinet is 30 1/2" high plus 4" levelers
- 2 adjustable shelves

# Specialty Cabinets

FULL HEIGHT  
BLIND CORNER



SKU

BFH42 (L,R)

**DESIGN CONSIDERATIONS**

- (L,R) refers to door hinge location
- Left side hinge is standard
- 42" W cabinet has a 14 7/8" W door
- Includes a 7" W slab filler where corner cabinet joint perpendicular cabinets
- 1 adjustable shelf

45 DEGREE  
CORNER BASE

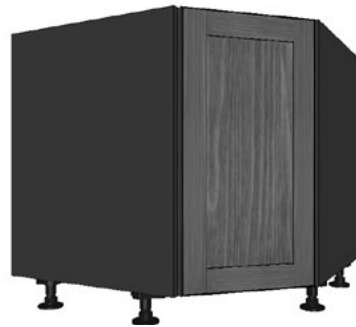

SKU

DCC3636 (L,R)

**DESIGN CONSIDERATIONS**

- Cabinet is 36" x 36"
- Door is 16" W x 30 1/4" H
- (L,R) refers to door hinge location
- 1 adjustable shelf

GALLEY SINK CAB



SKU

GS48 (L,R)  
GS72(L,R)

**DESIGN CONSIDERATIONS**

- Cabinet is 28" deep
- Top false front is 7" high
- Drawers 2 & 3 are 11 1/2" high
- Specify left or right for drawers
- The side opposite of the drawer is open under for plumbing clearance
- Drawer fronts over 8" can be ordered in a stile and rail configuration for an additional cost

# Specialty Cabinets

FARM SINK BASE



SKU

FSSB30-FSSB39

## DESIGN CONSIDERATIONS

- Standard 24" depth
- Depths available in 3" increments
- Available in 28" depth.
- Farm Sink False Front is 12-1/2" high.
- Bottom Doors are 17-3/4" High
- Reinforced Fixed Shelf
- Two Support Pieces shipped loose
- Full slab front to be cut-out by dealer.

WARMING DRAWER  
BASE 2-DOOR



SKU

WMDB30  
WMDB36

## DESIGN CONSIDERATIONS

- Standard 24" depth
- Available in 28" depth.
- Warming Drawer Front is 12-1/2" high.
- Bottom Doors are 17-3/4" High
- Partition on center.
- Two Support Pieces shipped loose
- Full slab front to be cut-out by dealer.

MICROWAVE  
DRAWER STACK

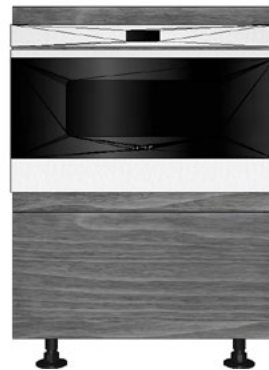

SKU

B2D24-B2D30

## DESIGN CONSIDERATIONS

- Standard 24" depth
- Depths available in 1" increments
- Available in 28" depth.
- Microwave Front is 18-5/8" high.
- Bottom Drawer Front is 11-1/2" High
- Full slab Microwave front to be cutout by dealer.



# Wall Cabinets

*Sonoma Collection / Sea White*



# Standard Wall Cabinet Specifications

**All ZählerBuilt boxes are constructed from 3/4 black HDPE**

- Full access, frameless construction
- 1/4" HDPE thick cabinet backs with 4" nailers top and bottom
- Use washers with stainless steel screws when hanging wall cabinets
- Wall cabinets are 13" deep and come with full depth 3/4" thick HDPE adjustable shelves
- Stainless steel, adjustable soft close hinges
- Finished ends, crown and light rails available as accessories
- We recommend a light rail for cabinets over 21" wide
- 11" Clear inside D

# Standard Wall Cabinets

## 1 DOOR CABIN



SKU

18" H  
W1218-W2118  
(L,R)

SKU

24" H  
W1224-W2124 (L,R)

SKU

30" H  
W1230-  
W2130(L,R)

SKU

36" H  
W1236-  
W2136(L,R)

### DESIGN CONSIDERATIONS

- (L,R) refers to door hinge location
- Width available in 1" increments (13-15,18)

### SHELVES

- 18" H - no shelves
- 24" H cabinets - 1 adjustable shelf
- 30" & 36" H cabinets - 2 adjustable shelves
- 13" deep outside, 11" clear inside

## 2 DOOR CABINET



SKU

18" H  
W2418-W3618

SKU

24" H  
W2424-W3624

SKU

30" H  
W2730-W3630

SKU

36" H  
W2436-W3636

### DESIGN CONSIDERATIONS

- (L,R) refers to door hinge location
- Width available in 1" increments (13-15,18)

### SHELVES

- 18" H - no shelves
- 24" H cabinets - 1 adjustable shelf
- 30" & 36" H cabinets - 2 adjustable shelves
- 13" deep outside, 11" clear inside



# Tall Cabinets

---

*Sonoma Collection / Alumina Special Order Color*



# Tall Cabinets

## 2-DOOR



### SKU

T1294-12(L,R)  
T1294-24(L,R)  
T1594-12(L,R)  
T1594-24(L,R)  
T1894-12(L,R)  
T2194-12(L,R)  
T2194-24(L,R)

## 4-DOOR



### SKU

T2494-12  
T2494-24  
T2794-12  
T2794-24  
T3094-12  
T3094-24

### DESIGN CONSIDERATIONS

- Standard height is 90 1/2" plus 4" levelers
- Top door is always 30" high
- Bottom door will vary with height change
- Fixed shelf between doors

- 6 adjustable shelves total
- Note depth (12" or 24") on order
- Note door swing on 2 door cabinet

An outdoor kitchen island featuring a stainless steel grill with a lid, a sink with a high-arc faucet, and a built-in dishwasher. The island has light-colored wood-grain cabinets and a white countertop. The background shows a stone pillar and a swimming pool.

## Panels, Fillers & Accessories

---

*Sonoma Collection / Sea White*



# Decorative Applied Panels

AP (WIDTH X HEIGHT X STYLE X FINISH)



## DESIGN CONSIDERATIONS

- Only available in custom sizes
- Reference the specifications section for additional information and limitations
- Appliance panels, please input the exact size required
- Note door style, color, width and height

# End Panels

## WINDSWEPT END/ BACK PANEL



### SKU

WEP1536  
WEP2642  
WEP1595  
WEP3042  
WEP3036  
WEP2695  
WEP3095

## SONOMA END PANEL



### SKU

SEP2636  
SEP2642  
SEP3036  
SEP3042  
SEP1430  
SEP1436  
SEP1495  
SEP2695  
SEP3095

### DESIGN CONSIDERATIONS

- All 'end panels' are shipped loose
- All 'end panels' are a slab (not decorative)
- Windswept is 3/4" thick
- Sonoma panels are 5/8" thick
- Standard Sonoma have an ebony edge
- Sonoma can be ordered with a matching front edge (add cost)
- Custom sizes available at additional cost
- Maximum size is 36" x 48" Sonoma
- If size exceeds maximum, need to order a 'back or tall panel'
- Windswept panels are finished on 1 long edge only
- Windswept back panels maximum width is 36" max height is 48"
- Sonoma requires a +/- 1/4" tolerance

# Sonoma Box Columns

SONOMA  
BOX COLUMN  
SHALLOW



SKU

SBCS-3x9X34.5  
SBCS-3x9X36  
SBCS-3x9X94.5

**DESIGN CONSIDERATIONS**

- 9 1/4" both sides
- 36" high for scribing as needed
- Matching mitered edge available for an added cost

SONOMA  
BOX COLUMN  
1 FULL SIDE

Ebony Edge Shown

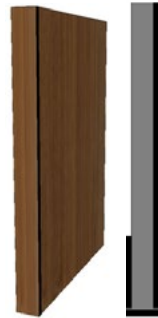

SKU

SBC1S-1.25x2636  
SBC1S-2.5x2636  
SBC1S-3x2634.5  
SBC1S-3x2636  
SBC-1S-4x2536  
SBC-1S-5x2536  
SBC-1S-6x2536  
SBC1S-3x2694.5

**DESIGN CONSIDERATIONS**

- 7 1/4" return 1 side
- 1 side full depth (26" or 30")
- 36" high is for scribing
- Matching mitered edge available for an added cost

SONOMA  
BOX COLUMN  
3 SIDES

Mitred Edge Shown



SKU

SBC3S-1.25x2636  
SBC3S-2.5x2636  
SBC3S-3x2634.5  
SBC3S-3x2636  
SBC3S-4x2636  
SBC3S-5x2636  
SBC3S-6x2636  
SBC3S-3x2694.5

**DESIGN CONSIDERATIONS**

- Both sides full depth (26" or 30")
- 36" high is for scribing
- Matching mitered edge available
- Custom sizing available at additional cost configuration for an additional cost

# Sonoma Box Columns

## SONOMA 4-SIDED BOX COLUMN



### SKU

- SBC4S-1.25x2536
- SBC4S-2.5x2636
- SBC4S-3x2536
- SBC4S-4x2536
- SBC4S-5x2536
- SBC4S-6x2536

### DESIGN CONSIDERATIONS

- 2 full returns and two matching faces
- 25" and 29" deep
- 36" high for scribing
- Matching mitered edge available for an added cost.

## SONOMA U-SHAPED BOX COLUMN



### SKU

- SBC-U-1.25x2536
- SBC-U-2.5x2536
- SBC-U-3x2536
- SBC-U-4x2536
- SBC-U-5x2536
- SBC-U-6x2536

### DESIGN CONSIDERATIONS

- 25" and 29" deep
- 36" high for scribing
- Matching mitered edge available for an added cost.

# Windswept Box Columns

## WINDSWEPT BOX COLUMN SHALLOW



### SKU

WBCS-1.5x9X36  
WBCS-2.25x9X36  
WBCS-3x9X36  
WBCS-3x9X36  
WBCS-4x9X36  
WBCS-5x9X36  
WBCS-3x9X94.5

### DESIGN CONSIDERATIONS

- 9" both sides
- 36" high for scribing as needed
- 3" wide

## WINDSWEPT BOX COLUMN 1 FULL SIDE



### SKU

WBC1S-1.5x2636  
WBC1S-2.25x2636  
WBC1S3x2634.5  
WBC1S3x2636  
WBC1S4x2636  
WBC1S-5x2636  
WBC1S-6x2636  
WBC1S-3x2694.5

### DESIGN CONSIDERATIONS

- 3" face x 7" one side x full depth 1 side

## WINDSWEPT BOX COLUMN 3 SIDES



### SKU

WBC3S-1.5x2636  
WBC3S-2.25x2636  
WBC3S-3x2634.5  
WBC3S-3x2636  
WBC3S-4x2636  
WBC3S-5x2636  
WBC3S-6x2636  
WBC3S-3x2694.5

### DESIGN CONSIDERATIONS

- Finished on 3" w face, side return and long inside edge
- 3" face with both sides finished full depth

# Windswept Box Columns

## WINDSWEPT 4-SIDED BOX COLUMN



SKU

WBC4S-1.25x2536  
WBC4S-2.5x2536  
WBC4S-3x2536  
WBC4S-4x2536  
WBC4S-5x2536  
WBC4S-6x2536

### DESIGN CONSIDERATIONS

- 2 full returns and two matching faces
- 25" and 29" deep
- 36" high for scribing

## WINDSWEPT U-SHAPED BOX COLUMN



SKU

WBC-U-1.25x2536  
WBC-U-2.5x2536  
WBC-U-3x2536  
WBC-U-4x2536  
WBC-U-5x2536  
WBC-U-6x2536

### DESIGN CONSIDERATIONS

- 25" and 29" deep
- 36" high for scribing

# Fillers & Floating Shelves

## SONOMA FILLER WITH BACKER

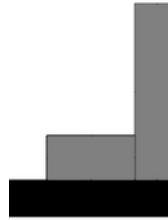

**SKU**

SF336  
SF394.5  
SF6536  
SF694.5

### DESIGN CONSIDERATIONS

- 7" both sides
- 36" high for scribing as needed
- 3" wide

## WINDSWEPT FILLER WITH BACKER



**SKU**

WF336  
WF394.5  
WF636  
WF694.5

### DESIGN CONSIDERATIONS

- 3" face x 7" one side x full depth 1 side

## WINDSWEPT FLOATING SHELF



**SKU**

WFS24(L,R,L&R,N)    WFS54(L,R,L&R,N)  
WFS30(L,R,L&R,N)    WFS60(L,R,L&R,N)  
WFS36(L,R,L&R,N)    WFS66(L,R,L&R,N)  
WFS42(L,R,L&R,N)    WFS72(L,R,L&R,N)  
WFS48(L,R,L&R,N)

### DESIGN CONSIDERATIONS

- Finished on 3" w face, side return and long inside edge
- 3" face with both sides finished full depth

(L) Finished Left    (L&R) Finished Left & Right  
(R) Finished Right    (N) Finished None

# Corner Fillers

SONOMA  
INSIDE CORNER  
FILLER

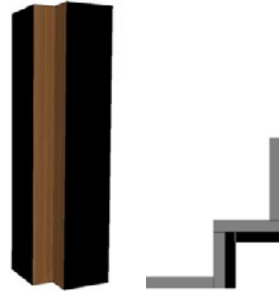

SKU

SICF3x336  
SICF6x636

**DESIGN CONSIDERATIONS**

- 3" x 3" inside filler
- Overall 9 5/8" x 9 5/8" x 36" high
- HDPE back filler

WINDSWEPT  
INSIDE CORNER  
FILLER

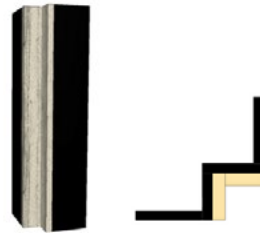

SKU

WICF3x336  
WICF6x636

**DESIGN CONSIDERATIONS**

- 3" x 3" inside filler
- Overall 10" x 10" x 36"
- Matching back filler

APPLIANCE  
PILASTER



SKU

APL336  
APL636

**DESIGN CONSIDERATIONS**

- Used to separate under counter appliances and support counter top
- HDPE back structure
- Specify 24" or 28" deep
- Available 3" or 6" wide
- Comes with front that matches door/drawer
- Standard height is 36"

# Posts

## SONOMA POST 3"

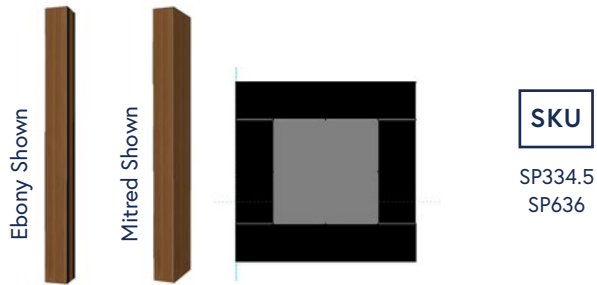

## SONOMA POST 6"

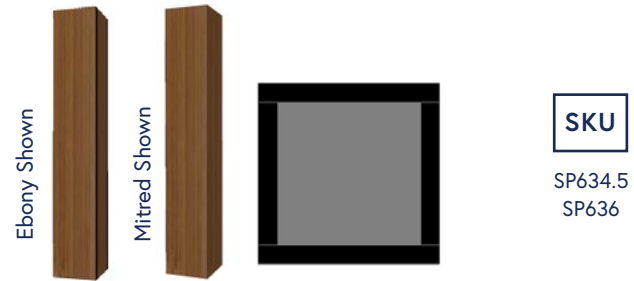

### DESIGN CONSIDERATIONS

- We define a post as having 4 finished sides
- Available 34 1/2" or 36" high
- Sonoma standard has 4 ebony edges
- Sonoma can be mitered all sides for additional cost

# Posts

## WINDSWEPT POST 3"

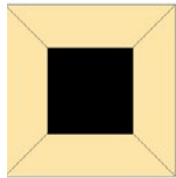

SKU

WP336

## WINDSWEPT POST 6"

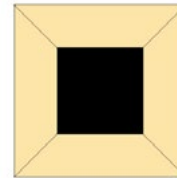

SKU

WP636  
Actual Net Size  
is 5 1/2" Square

### DESIGN CONSIDERATIONS

- We define a post as having 4 finished sides
- 36" high
- 3/4" thick material
- Windswept standard is mitered all sides
- 6" post is 5 1/2" square

# HDPE Panels & Toe Plates

## BLACK HDPE



SKU

HDPE2424 HDPE3696  
HDPE2448 HDPE4448  
HDPE2496 HDPE4896  
HDPE3648

### DESIGN CONSIDERATIONS

- 3/4" thick HDPE
- All edges unfinished

## WINDSWEPT TOE PLATE



SKU

WTP

### DESIGN CONSIDERATIONS

- 94" maximum standard length
- 5 1/2" standard height
- 5/8" thick
- Windswept primed all sides
- Finished color 1 face

## SONOMA TOE PLATE



SKU

STP

### DESIGN CONSIDERATIONS

- 94" maximum standard length
- 5 1/2" standard height
- 5/8" thick
- Windswept primed all sides
- Finished color 1 face
- Sonoma has 2 faces, ebony 2 edges

# Pulls & Accessories

## 1" KNOB



**SKU**  
SSK  
SSB

## 7" PULL

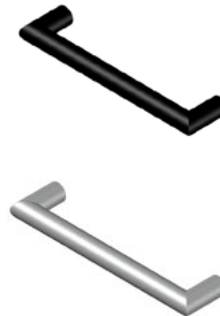

**SKU**  
SSP  
SSPB

### DESIGN CONSIDERATIONS

- Hardware is 304 stainless Powder coated clear or Black
- ZählerBuilt hardware is not drilled or mounted on doors and drawers.

## DOOR CAM LOCKS



**SKU**  
CAMLOCK

### DESIGN CONSIDERATIONS

- Locks are keyed alike
- Contact your rep for installed lock pricing

## TOUCH UP KIT



**SKU**  
TUK

### DESIGN CONSIDERATIONS

- Only available in base colors
- Order individually by color

# Accessories

## LEVELER SPACER



SKU

LS1

### DESIGN CONSIDERATIONS

- Adds 3/8" of Height per Spacer
- Can use up to 3

## LEVELER INSERT



SKU

LL3  
LL7

### DESIGN CONSIDERATIONS

- Modifies base cabinet heights from the stock 4" leg
- Standard leg adjusts from 3 3/4" to 5"
- LL3 adjusts from 2 1/2" to 4"
- LS7 adjusts from 6 3/4" to 7 3/4"

## LEVELER ADJUSTMENT TOOL



SKU

LAT

### DESIGN CONSIDERATIONS

- Used to adjust levelers during install

# Dealer Sales Tools

## DEALER MINI BASE



SKU

DMB

### DESIGN CONSIDERATIONS

- 13" W x 23" H x 13" D + toe
- Specify brushed stainless or black pull
- Color and finish is random, allow 4-6 weeks for requested finished

## DEALER SAMPLE DOOR



SKU

DSD

### DESIGN CONSIDERATIONS

- Standard sample doors is Windswept White
- 12 3/4" W x 15 3/4" high
- Allow 2 weeks lead time for colors other than white

## ZAHBOX (SAMPLES KIT)



SKU

DK

- 4 sample doors (Anvil, Cumulus, Virga, and Stratus)
- 1 set of blocks of both Windswept and Sonoma Collections
- Sample Block Holders.
- Colors on the door samples are predetermined and not selectable
- Cirrus and Neo doors not included must be ordered separately

## SONOMA SAMPLE BLOCKS



SKU

CSB

### DESIGN CONSIDERATIONS

- 6" x 6" x 5/8" thick blocks
- Includes stand

## WINDSWEPT SAMPLE BLOCKS



SKU

WSB

### DESIGN CONSIDERATIONS

- 6 blocks 2 3/4" W x 6" long
- Finished 1 edge 1 face



# Windswept Moldings

---



# ACCOYA®

A new way of thinking about wood



## PERFORMANCE

Excels in every way



WARRANTY



HIGHLY STABLE



HIGHLY DURABLE

## FINISH

Beautifully versatile



IDEAL FOR COATING



LOW MAINTENANCE



NATURAL WOOD

## SUSTAINABILITY

World-changing environmental credentials



SUSTAINABLY SOURCED



NON TOXIC



100% RECYCLABLE

Accoya turns everything you know about wood on its head. Through a revolutionary process called acetylation, it modifies wood to give it properties above and beyond the very best hardwoods - and in many cases, aluminum and PVC.

Highly durable and stable, Accoya withstands the test of any climate.

The warranty is a testament to the fact you will enjoy your Accoya wood for years to come.



To learn more visit:

[ACCOYA.COM](https://www.accoya.com)



Copyright © Accsys Technologies 2024. Accsys Technologies is a trading name of Titan Wood Limited. Accoya® and the Trimarque Device are registered trademarks owned by Titan Wood Limited and may not be used or reproduced without written permission.

# Windswept Crown

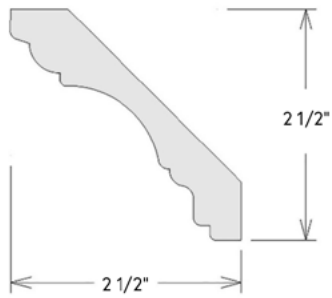

SKU

WSC71  
Net width is 3 1/2"W

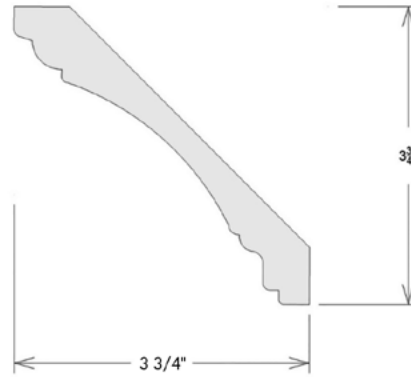

SKU

WSC50  
Net width is 5 1/4" W

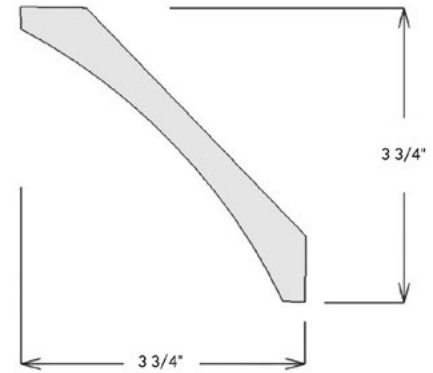

SKU

WSC103  
Net width is 5 1/4" W

## DESIGN CONSIDERATIONS

- If a nailer is needed please order
- Flat Stock or Base
- 94" maximum standard length
- Primed all sides
- Finished color on all exposed faces

# Windswept Crown

ZAH DOOR LOUVER

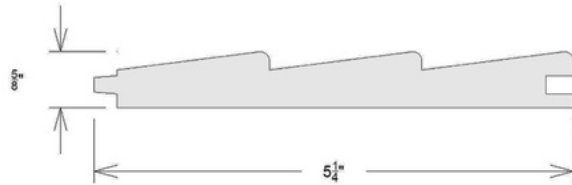

SKU

WSZL

NICKLE JOINT

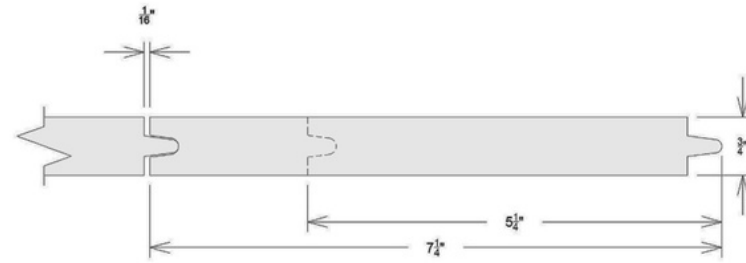

SKU

WSNJ5.25  
WSNJ7.25

"V" JOINT MISC 007  
(5 1/4" & 7 1/4")

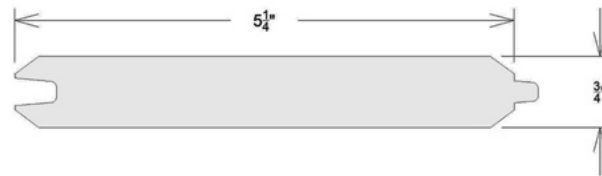

SKU

WSVJ

**DESIGN CONSIDERATIONS**

- 94" maximum standard length
- Primed all sides
- Finished color on all exposed faces

# Windswept Base Boards

PROFILE BASE



SKU

BP192.25  
BP195.25  
BP197.25

BEVELED BASE



SKU

BB3.25  
BB5.25  
BB7.25

DOOR PROFILE BASE



SKU

BDP3.25  
BDP5.25  
BDP7.25

## DESIGN CONSIDERATIONS

- 94" maximum standard length
- Primed all sides
- Finished color on all exposed faces



# Misc. Windswept Moldings

PICTURE FRAME MOLDING

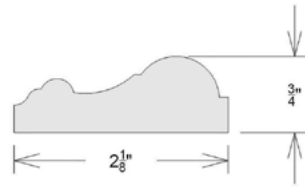

SKU

M095

**DESIGN CONSIDERATIONS**

- 94" maximum standard length

VALANCE

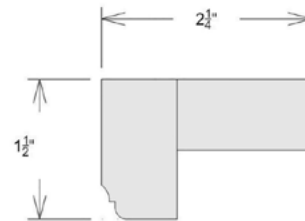

SKU

WSV  
CV

**DESIGN CONSIDERATIONS**

- 94" maximum standard length
- Primed all sides
- Finished color on 1 face and profiled edge

FLAT STOCK

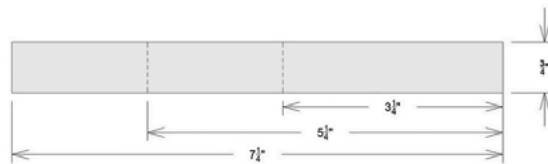

SKU

1x4x8  
1x6x8  
1x8x8

**DESIGN CONSIDERATIONS**

- Net size of 1x4x8 is  $\frac{3}{4}$ " x  $3\frac{1}{4}$ " x 94"
- Net size of 1x6x8 is  $\frac{3}{4}$ " x  $5\frac{1}{4}$ " x 94"
- Net size of 1x8x8 is  $\frac{3}{4}$ " x  $7\frac{1}{4}$ " x 94"
- Flat stock is primed all sides Finished
- Color on 1 face and 1 edge
- Additional Finished faces and edges at added cost



# Hoods

# Windswept Louver Hood

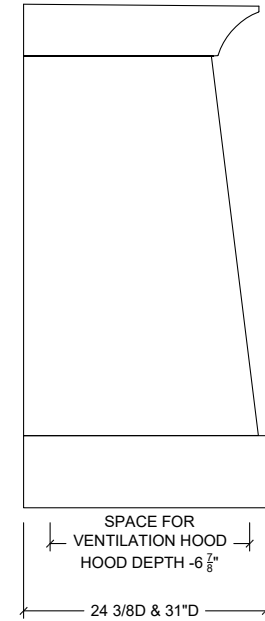
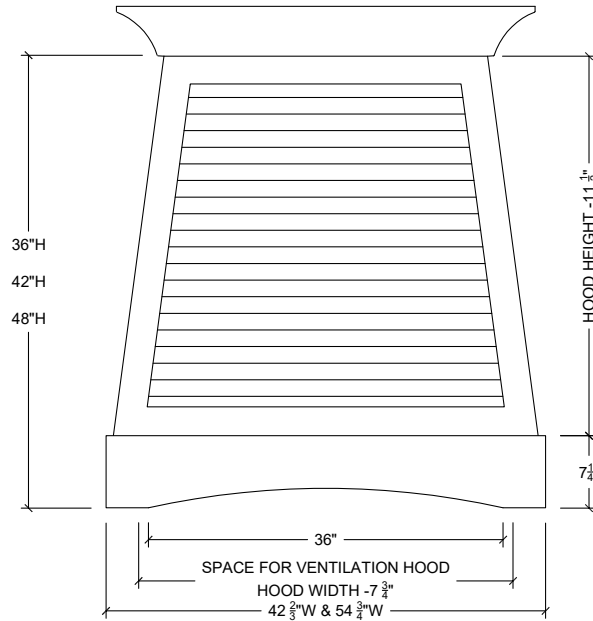

## DESIGN CONSIDERATIONS

- Widths available 44" and 55"
- Heights available 36", 42" and 48"
- Depths available 25" and 32"
- Crown molding is shipped loose and is optional
- Ventilator cut out is done on site
- Generally liner must be 36" above cooking surface

## SKU

LH4436-25	LH5536-25
LH4436-32	LH5536-32
LH4442-25	LH5542-25
LH4442-32	LH5542-32
LH4448-25	LH5548-25
LH4448-32	LH5548-32

# Windswept Shaker Hood

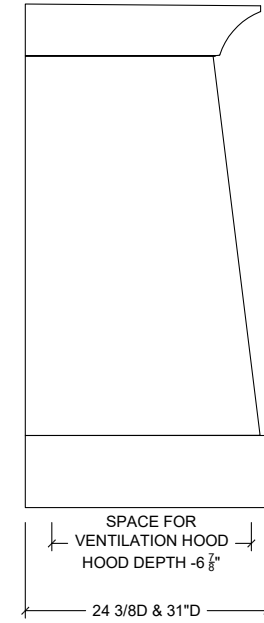
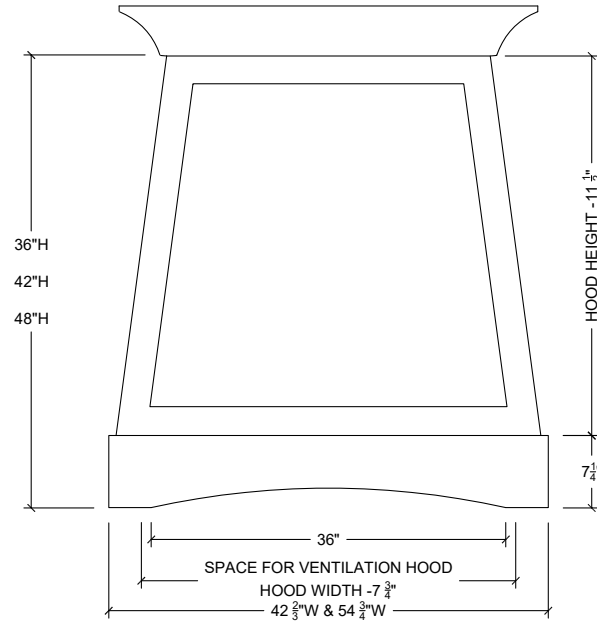

## DESIGN CONSIDERATIONS

- Widths available 44" and 55"
- Heights available 36", 42" and 48"
- Depths available 25" and 32"
- Crown molding is shipped loose and is optional
- Ventilator cut out is done on site
- Generally liner must be 36" above cooking surface

## SKU

SH4436-25	SH5536-25
SH4436-32	SH5536-32
SH4442-25	SH5542-25
SH4442-32	SH5542-32
SH4448-25	SH5548-25
SH4448-32	SH5548-32

# Windswept Nickel Joint Hood

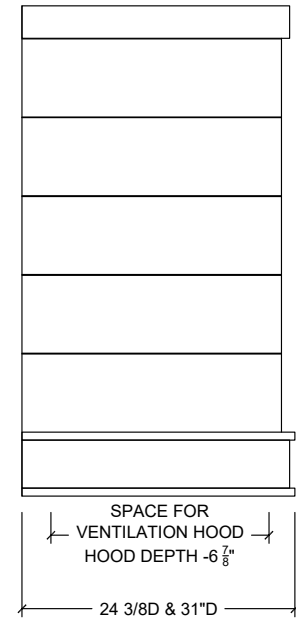
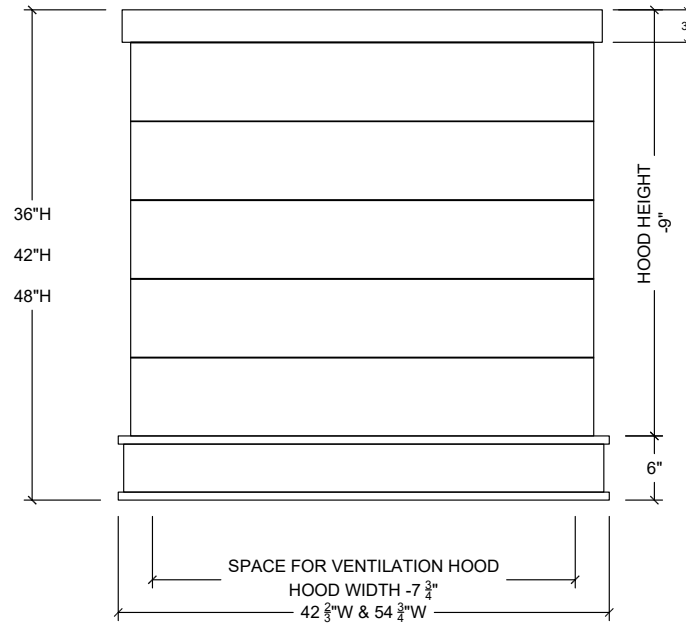

## DESIGN CONSIDERATIONS

- Widths available 44" and 55"
- Heights available 36", 42" and 48"
- Depths available 25" and 32"
- Crown molding is shipped loose and is optional
- Ventilator cut out is done on site
- Generally liner must be 36" above cooking surface

## SKU

NJH4436-25 NJH5536-25  
 NJH4436-32 NJH5536-32  
 NJH4442-25 NJH5542-25  
 NJH4442-32 NJH5542-32  
 NJH4448-25 NJH5548-25  
 NJH4448-32 NJH5548-32





Sonoma Collection / Royal Walnut



# ZÄHBUILT

Reimagining The Way We Live

 321-308-3297  SALES@ZAHBUILT.COM  325 EAST DRIVE, MELBOURNE, FL 32904 [ZAHBUILT.COM](http://ZAHBUILT.COM)

