

ultracraft®

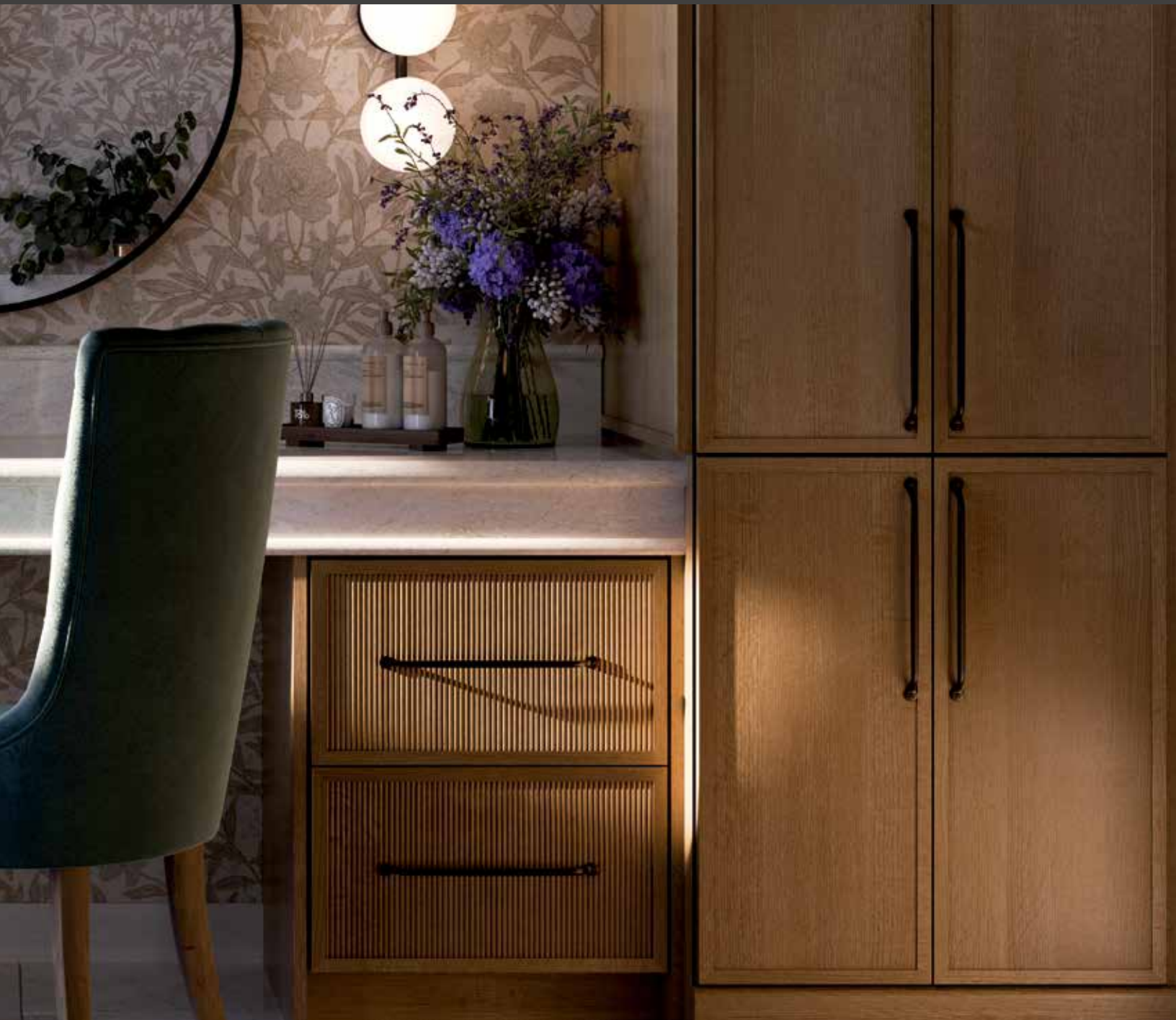



 For a gallery of additional photos and more information about UltraCraft, visit us on [Houzz.com](https://www.houzz.com).

Avon door style in Maple with Natural stain and Moss Green paint; AF002 Metal door style in Gold with Low Iron Clear Tech Glass.

Let's Get Started.

On the leading edge of fashion and function, our cabinetry offers uncompromising quality, fit, and finish.

Browse the pages here to see what is possible. Add your personal taste and imagination. Collaborate with your local kitchen designer and craft your custom kitchen for your unique home and lifestyle. When it's done, gather in family and friends and enjoy your new kitchen together.

- UltraLux: *Ultra Contemporary*..... 4-11
- See It In Your Mind. Hold It In Your Hands.....5
- Textured Melamine: *Today's Look and Feel* 12-23
- Thinking Outside The Box..... 17
- Thinking Inside The Box 21
- Thermofoil: *Easy Care and Value*24-29
- Wood: *Classic, Natural Beauty*..... 28-63
- Aurora Cabinet Lighting..... 33
- Mix, Match, and Marry 37
- Eurotek: *High Style, High Value* 64-65
- Metal: *A Glint of Jewelry*..... 68-71
- Glass: *Show Off A Little*.....70-73
- Accessories74-79
- Full Access Advantages: *Performance Construction* 80-81
- Cabinet Care82
- 100-year Limited Warranty.....83



South Beach door style in Pure White and Linear Silver UltraLux.

See It In Your Mind. Then Hold It In Your Hands.

Enjoy life-size samples of your favorite door/finish combinations in your home before you order cabinets.

Our color/finish/material/style combinations are virtually limitless! Your kitchen designer will help you define your favorite looks on your way to your new kitchen.

Sample doors are the best way to visualize what your ideas will look like in your home. Printed posters and brochures, and even designers' color chips, will never be as accurate - or as exciting - as a sample door custom-made to your specifications.

Before you order cabinets, order sample doors of the combinations you're most excited about. Live with the samples in your home until you know which look suits your family the best.





South Beach door style in Flint UltraLux.



Martin door style in Reclaimed Grey Textured Melamine and Acrilux II door style in Linear Bronze UltraLux.

Ultra Contemporary

UltraLux

If you want to maximize the contemporary style of your kitchen or bath, UltraLux is an excellent choice. Clean, sleek door designs add height to your room, while glossy, highly-reflective finishes make the whole room shine. Not a fan of high-gloss? We also offer matte finishes that give you the look of a painted door with increased durability. UltraLux's minimalism and Metal Drawer system will create a luxurious atmosphere and a sophisticated, contemporary appeal.

Our Metallic-look and Solid Color finishes are made by laminating a sheet of acrylic or polyethylene terephthalate (PET) to a door form made of medium-density fiberboard (MDF) and are engineered to be

the most scratch-resistant, high-gloss acrylic surfaces available. What more do you need... Dry Erase board performance? You got it. And when you wipe away the marker, the surface won't ghost—guaranteed!

Linear finishes feature a high-gloss laminate film with a subtle graphic and UltraMatte finishes are ideal if you want a silky look.

UltraLux can hold its own as a flagship feature in many defined styles such as modern, European, Asian, and minimalist. It will also deliver the look and feel of no-frills extravagance when combined with door styles and materials from our other programs.

Finishes

UltraMatte Acrylic

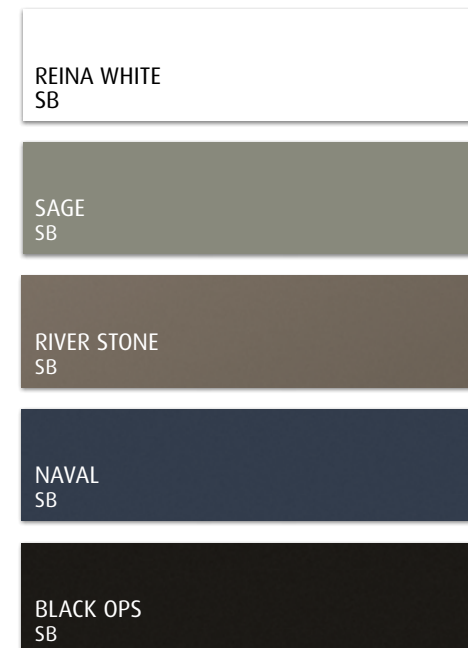

Linear-pattern, High-gloss Acrylic

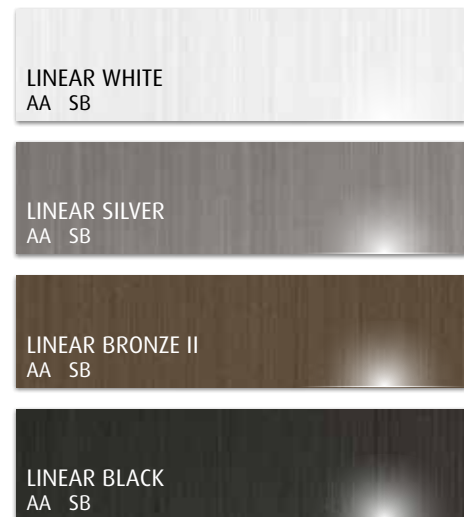

Metallic-look, High-gloss Acrylic

The most scratch-resistant, high-gloss acrylic surface available. Dry Erase-certified. Guaranteed never to ghost!



Door Styles



ACRILUX II

Slab drawer front
Shown in Linear Silver
Available in every high-gloss finish
Aluminum-look edgebanding
Available with Integrated Pulls (page 15)

EDGEWATER

Slab drawer front
Shown in Champagne Metallic
Available in all Solid Color and Metallic-look high-gloss finishes
Two-tone edgebanding

SOUTH BEACH

Slab drawer front
Shown in Carbon
Available in every finish
Matching edgebanding
Available with Integrated Pulls (page 15)

Solid-color, High-gloss Acrylic

The most scratch-resistant, high-gloss acrylic surface available. Dry Erase-certified. Guaranteed never to ghost!

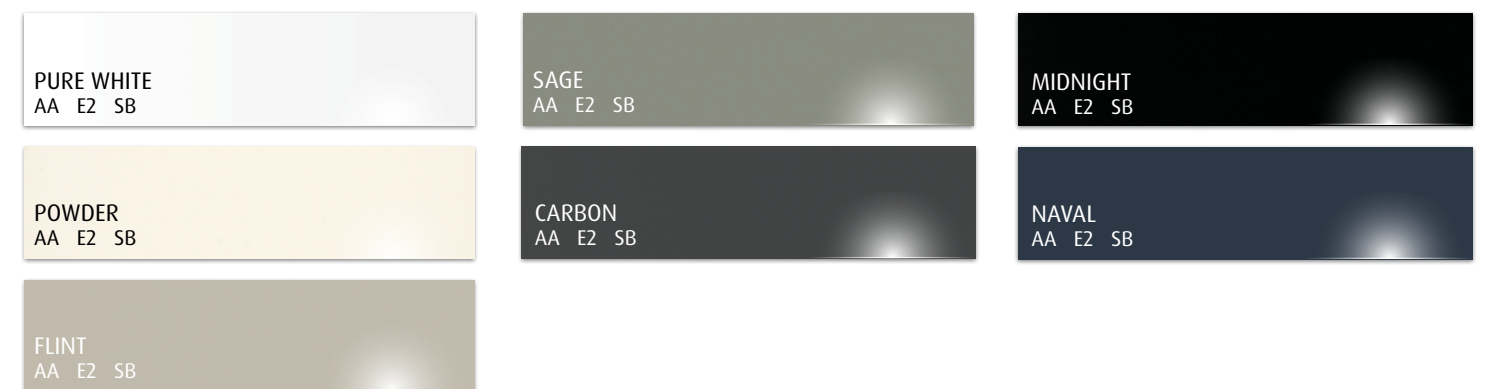

Finish availability by door style:
AA = Acrilux II/Aluminum-look Edgebanding E2 = Edgewater/Two-tone Edgebanding SB = South Beach/Matching Edgebanding

Not all colors and finishes are available on all door styles. Printed and digital materials should never be used for color matching. We recommend ordering a sample door to see the best representation of your selected color, finish, and wood grain contrast and patterns on your selected door style, before ordering cabinetry. Sample doors are more accurate than any website, printed literature, or designer's color chips. See your designer for details.



Piper door style in Sienna Textured Melamine and Marshall door style in Moss Green paint.



Metropolis door style in Silver Elm Textured Melamine and South Beach door style in Linear White UltraLux.



Piper door style in Charred and Archicrete Textured Melamine and AF006 door style in Natural Aluminum with Bronze Matte Tech Glass inserts.

Thinking Outside The Box

Our door materials are available as panels that can be used in your kitchen to cover... well, most anything. This homeowner and kitchen designer chose Archicrete Textured Melamine panels to wrap the island sides and back. Archicrete looks like concrete and ramps up the industrial style in this kitchen. Why not a "concrete" wall too? More panels cover the wall behind the cabinets all the way up to the high ceiling.



In addition to faux-concrete panels, we offer subtle-to-bright colors, silky matte, high-gloss, aluminum, paint, textures, real wood, and simulated wood from bleached to weathered to charred.

Today's Look and Feel

Textured Melamine

Smooth is no longer the only option. Textured Melamine is becoming one of the most popular options for today's homeowners. Choose the 3D character and feel of a wood door but in a product that's unaffected by humidity, easy to care for, and affordably priced.

Modern technology has made melamine an incredibly attractive option in both price and look. Our Textured Melamine doors are made by thermally-fusing a printed, resin-covered, textured paper to a door form made of medium-density fiberboard (MDF). The result is a durable,

low-maintenance finish with an exciting texture that simulates a variety of real woods.

Our offering of Textured Melamine includes popular door styles which you can combine with an array of colors, wood grains, horizontal or vertical grain directions, and degrees of texture.

If you want to create a warm, inviting room but prefer a wood-alternative product that can stand up to your life at home, try Textured Melamine.



Finishes

Fine-Textured

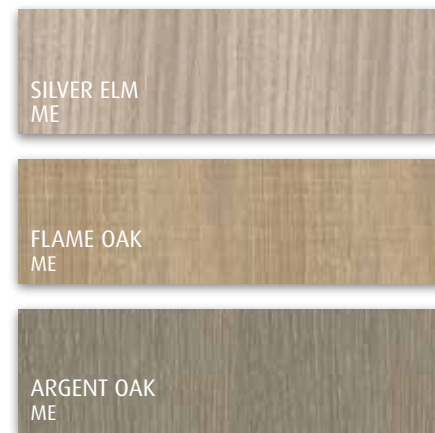

Finish availability by door style:
 ME = Metropolis KH = Kitty Hawk
 P = Piper MA = Martin

Door Styles



METROPOLIS
 Slab drawer front
 Available with either vertical or horizontal grain direction
 Shown in Flame Oak Vertical
 Available with Integrated Pulls (page 15)



PIPER
 Slab drawer front
 Available with either vertical or horizontal grain direction
 Shown in Light Carbonite Horizontal
 Available with Integrated Pulls (page 15)



KITTY HAWK
 Slab or 5-PC drawer front
 Features both vertical and horizontal grain directions which cannot be altered
 Shown in Vineyard Oak



MARTIN
 3-PC drawer front
 Features both vertical and horizontal grain directions which cannot be altered
 Shown in Wired Silver

Coarse-Textured

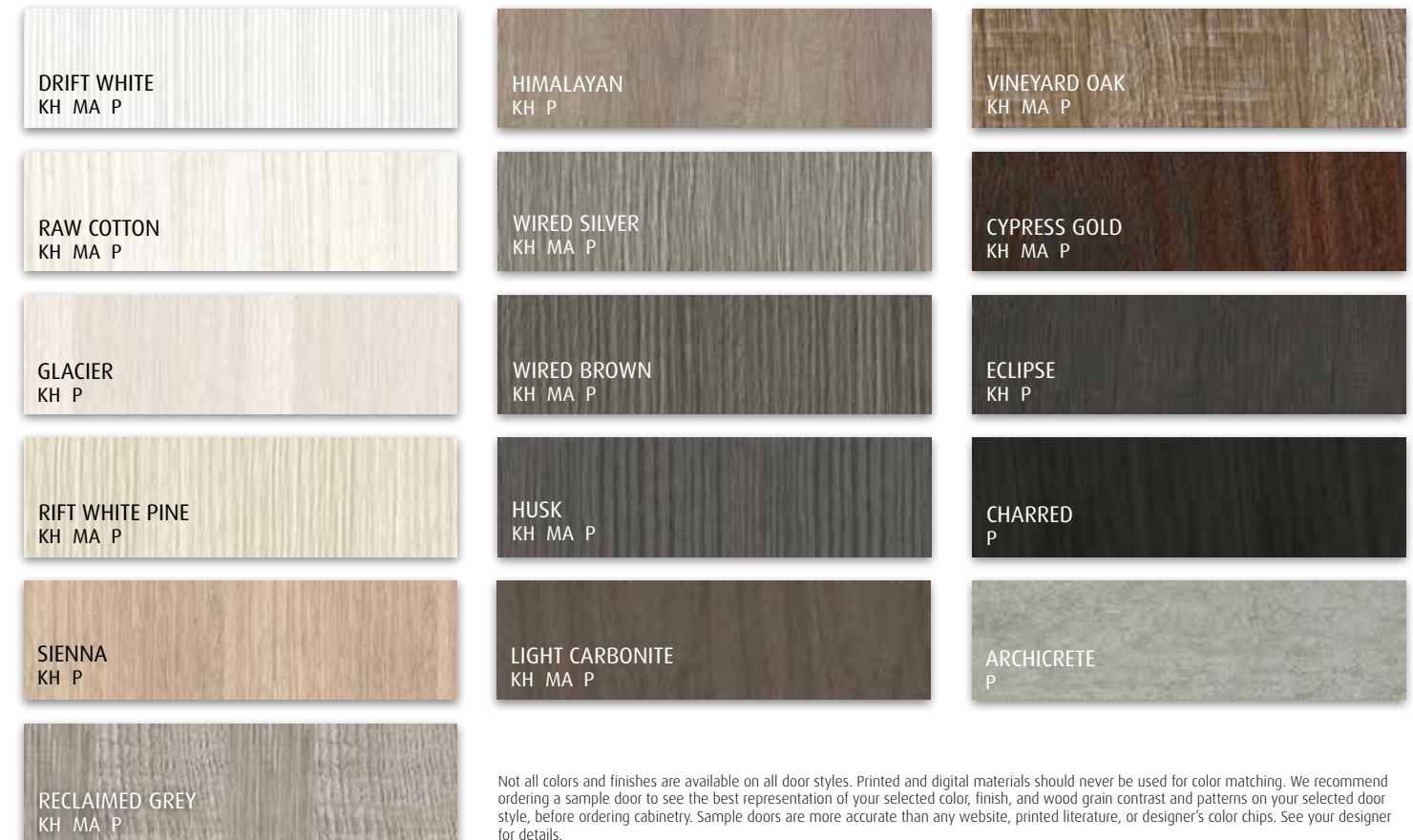

Not all colors and finishes are available on all door styles. Printed and digital materials should never be used for color matching. We recommend ordering a sample door to see the best representation of your selected color, finish, and wood grain contrast and patterns on your selected door style, before ordering cabinetry. Sample doors are more accurate than any website, printed literature, or designer's color chips. See your designer for details.



Piper door style in Vineyard Oak Textured Melamine and South Beach door style in Naval UltraMatte UltraLux.

Thinking Inside The Box



15% MORE STORAGE SPACE!

Full-access cabinets have up to 15% more storage space than framed cabinets. And no knuckle-nicking frame or center stile to impede access to stored items. Go ahead and buy those large plates you've had your eye on.

INTERIOR FINISHES

Insides (and outsides!) are protected with moisture-resistant, easy-to-clean melamine. Interiors of cabinets with glass doors, or no doors, are color-coordinated to look great with the overall look of the kitchen.

EDGES

Front edges have matching or coordinating edgebanding. All edges (except inside edges of top stretchers) are covered for moisture-resistance.

SHELVES

Adjustable, full-depth shelves are 3/4"-thick, edgebanded, and supported with metal shelf clips.

HINGES

Durable, self-closing hinges are 6-way-adjustable for precision door alignment.

Learn more about Advantages and Performance Construction on pages 80-81.



Piper door style in Sienna Textured Melamine and South Beach door style in Black Ops UltraMatte UltraLux. Wall panels in Archicrete and Sienna Textured Melamine.



Adriatic door style in Matte White Thermofoil, AF003 Metal door style in Onyx with Clear Tech Glass, and Sienna Textured Melamine panels.

Easy Care and Value

Thermofoil

Our Thermofoil doors bring you easy maintenance, long-lasting durability and beautiful styles, colors, and finishes, making this option one of the best values in cabinetry.

Made by the heat-and-vacuum application of a rigid vinyl to a door form made of medium-density fiberboard (MDF), Thermofoil doors provide a flawless finish with a clean, smooth surface and superior stability.

Thermofoil is low-maintenance due to its moisture-, chip-, and stain-resistant finishes. Its easy care is appealing to

many busy families. For most kitchen splatters and spills, Thermofoil cabinets can be easily wiped clean with a soft, damp cloth.

Door styles range from modern square- and beveled-edge slabs to traditional raised-panel looks with transitional, Shaker-style in-between. High-gloss on a slab-style door shouts urban contemporary, but any color on a door with a center panel captures the beauty of classic painted wood at a much lower cost.

Door Styles:

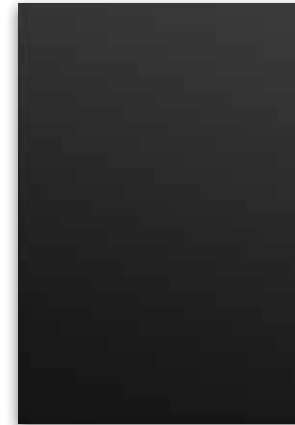

ADRIATIC
Slab drawer front
Available in all Thermofoil finishes
Shown in Coal



MISSION II
Slab or Matching drawer front
Available in Matte White, Satin White, Shark, Coal, and Haze
Shown in Shark



LEXINGTON
Slab or Matching drawer front
Available in Matte White, Satin White, Coal, and Haze
Shown in Haze



CELLINI
Matching Slab drawer front
Available in all Thermofoil finishes
Shown in Silver Walnut



Adriatic door style in Shark Thermofoil. Designer: Jorge A. Martinez, CKD, Designer Kitchens LA.

Finishes:



MATTE WHITE

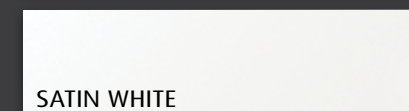

SATIN WHITE

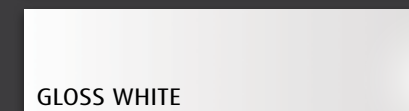

GLOSS WHITE

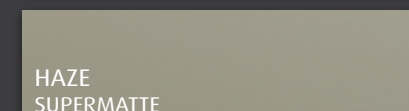

HAZE
SUPERMATTE



SHARK

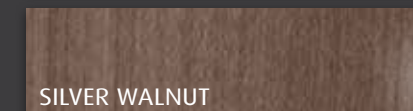

SILVER WALNUT

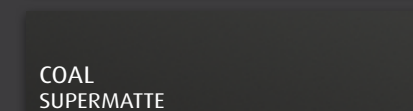

COAL
SUPERMATTE

Not all colors and finishes are available on all door styles. Printed and digital materials should never be used for color matching. We recommend ordering a sample door to see the best representation of your selected color, finish, and wood grain contrast and patterns on your selected door style, before ordering cabinetry. Sample doors are more accurate than any website, printed literature, or designer's color chips. See your designer for details.



Richmond II door style in Walnut with Natural stain (low sheen) and Adriatic door style in Coal SuperMatte Thermofoil.*

**Walnut is prized for its natural, wide-ranging variations in grain contrast, patterns, and color. Since no single image can capture the variety possible with Walnut, please consult with your designer about what to expect.*



Avon door style in Maple with Moss Green paint.



Avon door style in Maple with Natural stain. AF002 Metal door style in Gold with Low Iron Clear Tech Glass.



Aurora Cabinet Lighting

A new kitchen is not complete without a custom-designed lighting plan for safely performed tasks, beautiful displays, and appropriate mood. Aurora is an energy-efficient, low-voltage, LED plug-and-play system that is easy to design and install. Work with your kitchen designer to illuminate your new kitchen in every right place.

- Wall Switch or phone app adjusts
 - ▷ On/Off
 - ▷ Brightness high-to-low
 - ▷ Temperature warm-to-cool
 - ▷ Wireless Bluetooth operation
- More than 50,000 hours (23 years!) of average daily use
- 5-year manufacturer's warranty



PUCK LIGHTS
Ideal for showing off decorative items behind glass. Above wall cabinets, Puck Lights create circles of light on the ceiling.



LIGHT BARS
Beneath wall cabinets, Light Bars brighten countertops. Beneath open shelves they accentuate your fine taste in art.



LIGHT RIBBONS
Use above wall cabinets to set the mood, below wall cabinets to light countertops, and at toe kicks to night-light.

Marshall door style in Quartersawn White Oak with Natural stain and Maple with Melted Brie Paint; AF017 Metal door style in Graphite.



Andover door style with Arctic White paint and Brown Linen glaze. Designer: Samina Datta, Reico Kitchen & Bath. Photo: BTW Images, LLC.



Mix, Match, and Marry

These days many kitchen designs include an island in a different color, finish, or material than the perimeter cabinets. Here lighter, stained wood is paired with darker, painted wood in a contrasting color and in two different door styles.

We love designs that pair recessed panel wood doors with slab wood doors. Gloss looks even brighter when paired with matte. Texture works well with both gloss and matte.

There are no limits. Choose more than one combination. Order sample doors of your pairings and look at them in your home to help you decide.

Here are a few of our favorites:

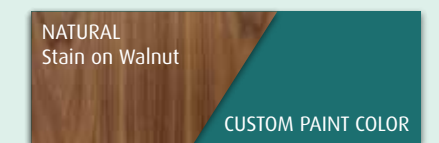
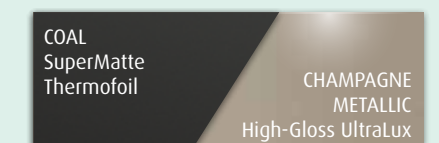
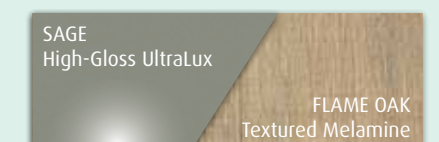
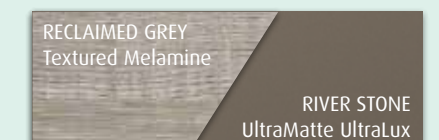
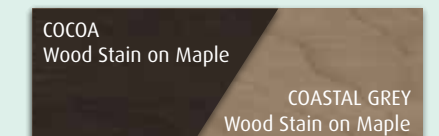

Stickley door style in Rustic Alder with Natural stain and Lakeway door style with Blue Ash paint.

Classic, Natural Beauty

Wood Door Styles

Wood is the most traditional choice for cabinet doors. Our Wood Program provides an incredible range of options that are relevant to today's design and architectural styles. You can achieve almost any look or ambiance you want by marrying the door styles, colors, and finishes that excite you.

Our selection of door styles is diverse: simple, traditional, ornate, multi-dimensional, raised panels, recessed panels, wide stiles, thin stiles, and more. And keep in mind each door can provide a very different look depending on the colors, finishes, and drawer fronts you combine.

Because they are a natural material, wood doors add an overall softness to kitchens, yet are strong and durable. Enhance their natural beauty with stains and finishes that allow the unique characteristics of your wood species to come through, like knots, color variations, and grain patterns. Or have your doors painted for a bolder, more consistent color presentation, still awarding you with wood's comfortable attitude.

Need a little more character than a stain or paint can provide? Check out our low-charge, specialty glaze and distressed finishes to further influence your unique look.

Recessed Panel Wood Door Styles



LAUDERDALE
Slab or 5-PC drawer front
Shown in Maple, Cocoa
O M C A



BRECKENRIDGE
5-PC drawer front
Shown in Melted Brie
O M C RC A RA RB QWO



MARSHALL
Slab or 5-PC drawer front
Shown in Walnut,* Natural
O M C A RB W QWO



LAKEWAY
Slab or 5-PC drawer front
Shown in Pebble Grey
O M C A RB QWO



AVON
Slab or 5-PC drawer front
Shown in Arctic White
O M C A RB W MDF QWO



ANDOVER
Slab or 5-PC drawer front
Shown in Maple, Briarwood,
Brown Glaze
O M C A RB



AVON WIDE
Slab or 5-PC drawer front
Shown in Arctic White
O M C A RB MDF QWO



BOCA RATON
5-PC drawer front
Shown in Cherry, Wenge
O M C MDF QWO



BRECKENRIDGE WIDE
5-PC drawer front
Shown in Maple, Caramel,
Mocha Glaze
O M C RC A RA RB QWO



BRIGGS
Slab or 5-PC drawer front
Shown in Basil
O M C A RB



BRISTOL
Slab or 5-PC drawer front
Shown in Beach White
O M C A RB QWO



CADEN
Slab or 5-PC drawer front
Shown in Seagrass
O M C A RB MDF



CASSIDY
Slab or 5-PC drawer front
Shown in Aria
O M C A RB



CHARLOTTE
Slab or 5-PC drawer front
Shown in Maple, Saddle
O M C A RB MDF



CONNOR
Slab or 5-PC drawer front
Shown in High Park
O M C RC A RA RB



DAYTONA
Slab or 5-PC drawer front
Shown in Oak, Briarwood
O M C A RB QWO



DENNISON
Slab or 5-PC drawer front
Shown in Cherry, Caramel
O M C A RB



FRISCO
5-PC drawer front
Shown in Maple, Briarwood
O M C



HAMPTON
Slab or 5-PC drawer front
Shown in Moon Bay,
Brown Glaze
O M C A RB



LAFAYETTE
Slab or 5-PC drawer front
Shown in Maple, Coastal Grey,
Mocha Glaze
O M C A RB QWO

Available Species: O=Oak M=Maple C=Cherry RC=Rustic Cherry
A=Alder RA=Rustic Alder RB=Red Birch W=Walnut
MDF=Medium Density Fiberboard QWO=Quartersawn White Oak

Not all colors and finishes are available on all door styles. Printed and digital materials should never be used for color matching. We recommend ordering a sample door to see the best representation of your selected color, finish, and wood grain contrast and patterns on your selected door style, before ordering cabinetry. Sample doors are more accurate than any website, printed literature, or designer's color chips. See your designer for details.

*Walnut is prized for its natural, wide-ranging variations in grain contrast, patterns, and color. Since no single image can capture the variety possible with Walnut, please consult with your designer about what to expect.

Recessed Panel Wood Door Styles, cont.



SHAKER
Slab or 5-PC drawer front
Shown in Walnut,* Natural
O M C A RB W MDF QWO



WICKER PARK
Slab or 5-PC drawer front
Shown in Blue Ash
O M C RC A RA RB W QWO



ROCKFORD
Slab or 5-PC drawer front
Shown in Alder Storm Grey
O M C A RB W QWO



PLAINVIEW WIDE
Slab or 5-PC drawer front
Shown in Red Birch, Natural
O M C A RB MDF QWO



OAKLAND PARK
Slab or 5-PC drawer front
Shown in Balboa Mist,
Brown Linen
O M C A RB

**Walnut is prized for its natural, wide-ranging variations in grain contrast, patterns, and color. Since no single image can capture the variety possible with Walnut, please consult with your designer about what to expect.*

Not all colors and finishes are available on all door styles. Printed and digital materials should never be used for color matching. We recommend ordering a sample door to see the best representation of your selected color, finish, and wood grain contrast and patterns on your selected door style, before ordering cabinetry. Sample doors are more accurate than any website, printed literature, or designer's color chips. See your designer for details.



MATHIS
5-PC drawer front
Shown in Quartersawn White
Oak in Dune
O M C W QWO



NASHTON WIDE
Slab or 5-PC drawer front
Shown in Pebble Grey
O M C A RB QWO



OLIVER
Slab or 5-PC drawer front
Shown in Seagrass
O M C A RB



PLAINVIEW
Slab or 5-PC drawer front
Shown in Melted Brie
O M C A RB MDF QWO



PLANTATION
Slab or 5-PC drawer front
Shown in Oak, Cocoa
O M C RC A RA RB



RIDGECREST
Slab or 5-PC drawer front
Shown in Moon Bay
O M C A RB W QWO



SAGAMORE
Slab or 5-PC drawer front
Shown in Alder, Storm Grey
O M C RC A RA RB QWO



SAYER
Slab or 5-PC drawer front
Shown in Oak, Storm Grey
O M C RC A RA RB



SHAKER WIDE
Slab or 5-PC drawer front
Shown in Red Birch, Natural
O M C A RB MDF QWO



STICKLEY
Slab or 5-PC drawer front
Shown in Rustic Alder, Natural
O M C RC A RA RB QWO



STICKLEY WIDE
Slab or 5-PC drawer front
Shown in Oak, Chestnut
O M C RC A RA RB QWO



WINCHESTER
5-PC drawer front
Shown in Maple, Briarwood
O M C RC A RA RB



Plainview Wide door style in Rag & Bone paint. Designer: Tres Jolie Maison. Photo: Kim Smith.

O=Oak M=Maple C=Cherry RC=Rustic Cherry A=Alder RA=Rustic Alder RB=Red Birch W=Walnut MDF=Medium Density Fiberboard QWO=Quartersawn White Oak

Raised Panel Wood Door Styles



ASHEVILLE
5-PC drawer front
Shown in Maple, Cocoa,
Brown Glaze
O M C RC A RA RB QWO



BOSTON
Contoured Slab or
5-PC drawer front
Shown in Cherry, Nutmeg,
Brown Glaze
O M C RC A RA RB QWO



EVANSTON
Slab or 5-PC drawer front
Shown in Mineral Grey,
Brown Glaze
O M C RC A RA RB QWO



FAIRLAWN
Slab or 5-PC drawer front
Shown in Rustic Cherry,
Chestnut
O M C RC A RA RB QWO



LIVINGSTON
5-PC drawer front
Shown in Cherry,
Peppercorn
O M C RC A RA RB



MOUNT VERNON
5-PC drawer front
Shown in Red Birch, Porcini
O M C RC A RA RB



PLYMOUTH
5-PC drawer front
Shown in Cherry, Briarwood
O M C



RAISED
Slab or 5-PC drawer front
Shown in Maple, Amber
M C



ROYALTON
Slab or 5-PC drawer front
Shown in Vintage Wings
O M C RC A RA RB

O=Oak M=Maple C=Cherry RC=Rustic Cherry A=Alder RA=Rustic Alder RB=Red Birch
W=Walnut MDF=Medium Density Fiberboard QWO=Quartersawn White Oak



Evanston door style in Oak with Platinum Grey stain.

Not all colors and finishes are available on all door styles. Printed and digital materials should never be used for color matching. We recommend ordering a sample door to see the best representation of your selected color, finish, and wood grain contrast and patterns on your selected door style, before ordering cabinetry. Sample doors are more accurate than any website, printed literature, or designer's color chips. See your designer for details.

A Clean and Simple Wood Look

Slab Wood Door Styles

Slab-style doors are the most modern of the wood looks, and are often seen in contemporary-style kitchen designs. Other than optional knobs or pulls, the only ornamentation on a slab door is the finish itself—any paint color or striking wood veneer. Choose paint and the

look will be about color. Choose wood veneer and show off the unique grain patterns of natural wood.

Unlike solid wood, these doors are virtually unaffected by changes in temperature and humidity.



Richmond II door style in Walnut with Natural stain. Designer: Gretchen Ferreira of Style Bath & Kitchen and Meryl Phillips-Miller of Meryl & Miller. Open Homes Photography.*



RICHMOND II
Eased edge
Slab drawer front
Wood veneer, vertical grain only
Available in Oak, Maple, Cherry, Walnut and Quartersawn White Oak with Stain finishes only; no Specialty finishes
Shown in Walnut* in Natural



Slab door style in Oak with Storm Grey stain.



SLAB
Square edge
Slab drawer front
Wood veneer, vertical grain only
Available in Oak, Maple, Cherry and Quartersawn White Oak with Stain finishes only; no Specialty finishes
Shown in Oak in Storm Grey



Apex door style with Moon Bay paint.



APEX
1/8" Round-over edge
Slab drawer front
MDF door available in any Paint color and Linen finishes only
Shown in Moon Bay



Richmond II door style in Oak with Storm Grey stain.

*Walnut is prized for its natural, wide-ranging variations in grain contrast, patterns, and color. Since no single image can capture the variety possible with Walnut, please consult with your designer about what to expect.

Celebrate the Nature of Wood

Stained Wood

Pair your favorite hint of color with the natural beauty of wood and turn your new cabinetry into fine furniture for your kitchen. Our 14-step finishing process adds depth and richness to wood's color while bringing out the beauty of the grain.

Specialty Finishes



BROWN GLAZE MOCHA GLAZE NICKEL GLAZE

Glaze

Wood is stained or painted, then if desired, distressed. Glaze is hand-applied and rubbed away leaving color collected in crevices unique to each door style.



Aged

Stained or painted wood is randomly dented with special tools to cause stress cracks, and sealed with a clear top coat.



Worn

A blend of rasping, stress cracks, worm holes, dents, and smoothly worn edges. Available on stains with Low Sheen.

Hand-applied glazing and distressing are custom effects and will be slightly different on each application.

Maple



Alder and Rustic Alder

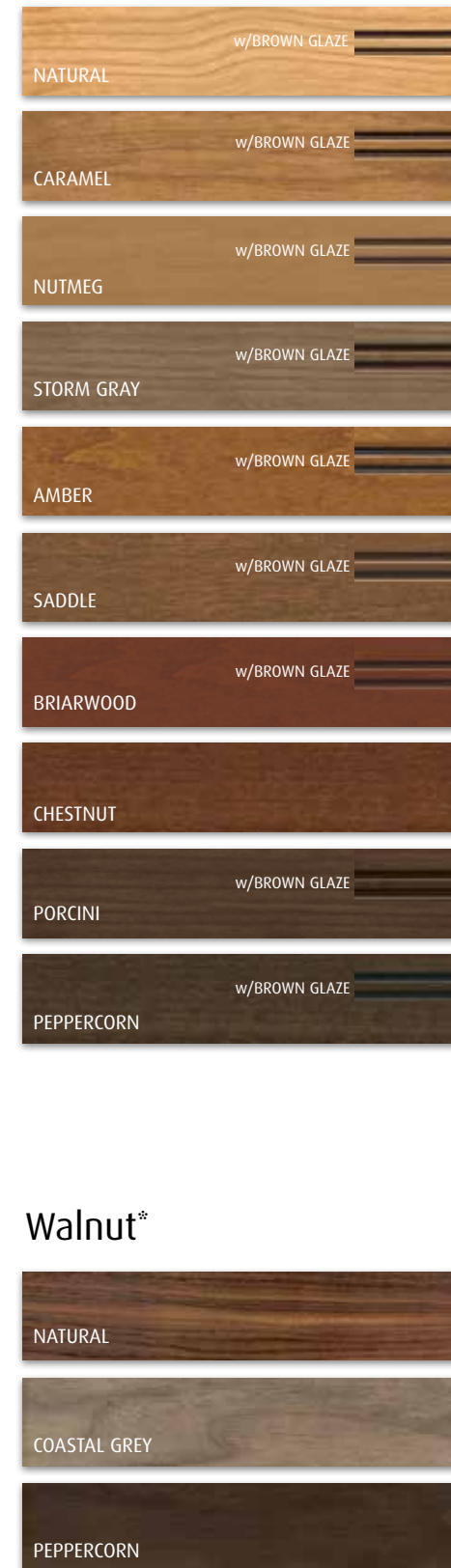

Walnut*



*Walnut is prized for its natural, wide-ranging variations in grain contrast, patterns, and color. Since no single image can capture the variety possible with Walnut, please consult with your designer about what to expect.

Quartersawn White Oak

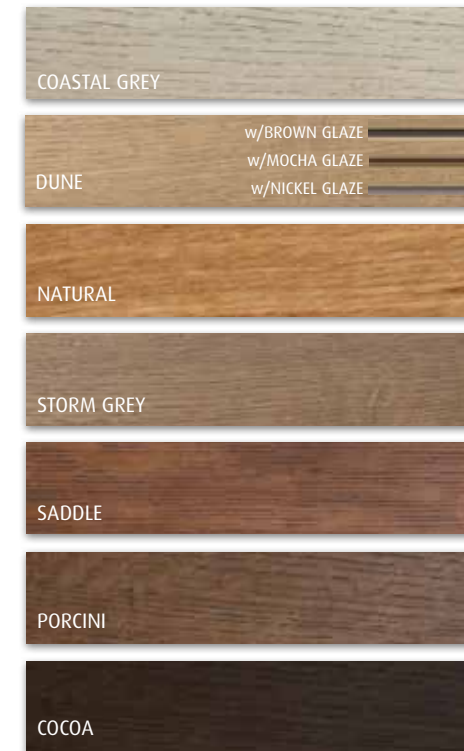

Red Birch

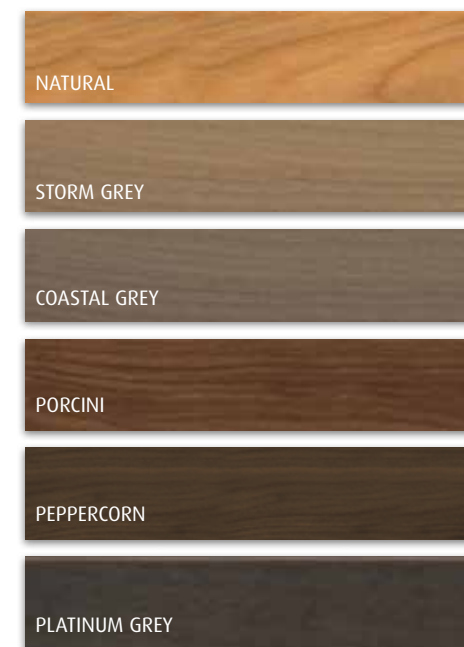

Oak

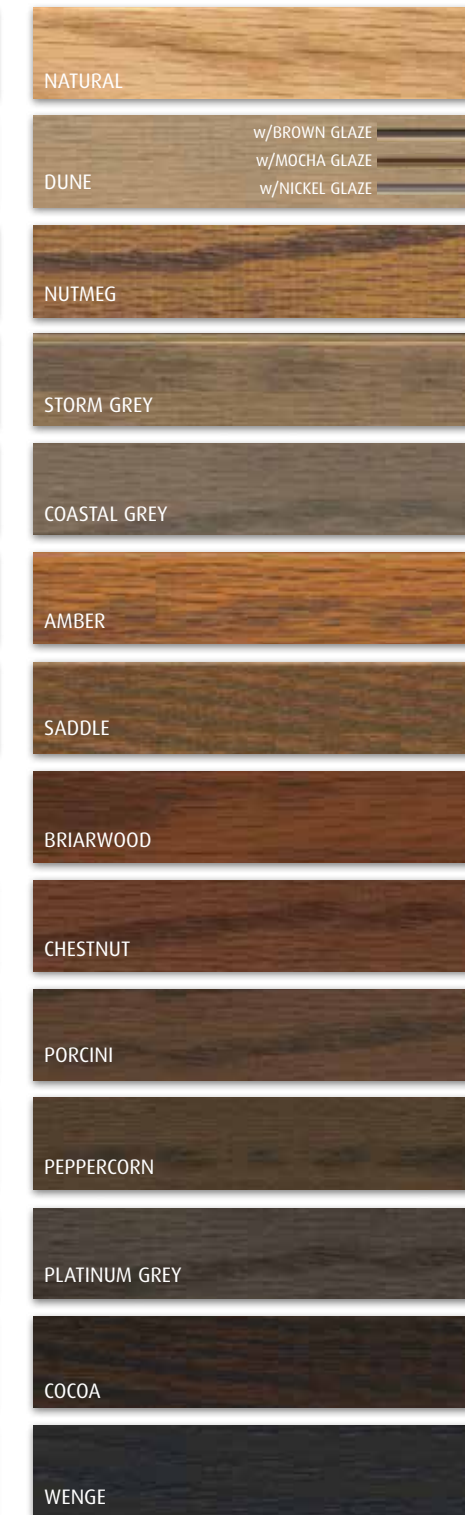

Cherry and Rustic Cherry

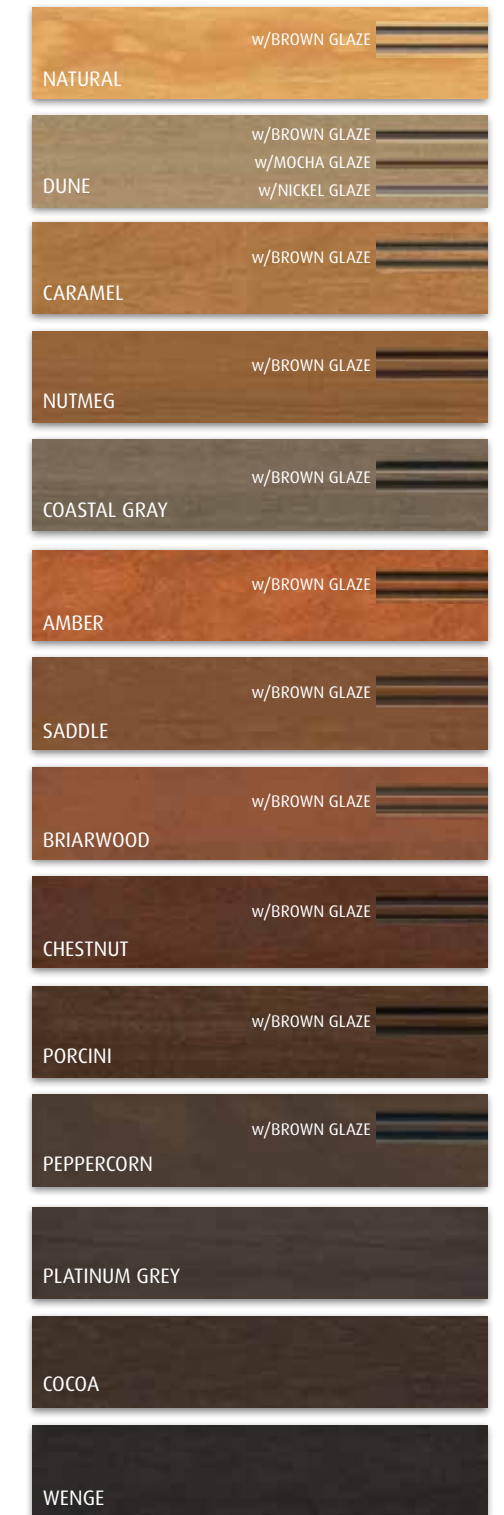

Not all colors and finishes are available on all door styles. Printed and digital materials should never be used for color matching. We recommend ordering a sample door to see the best representation of your selected color, finish, and wood grain contrast and patterns on your selected door style, before ordering cabinetry. Sample doors are more accurate than any website, printed literature, or designer's color chips. See your designer for details.

Time-Honored and Current

Painted Wood

Painted wood doors are as popular as ever. We use a 14-step, furniture-finishing process for beauty and durability topped off with either Standard or Low Sheen. You can stop there, or you can layer in hand-applied specialty techniques for an even richer, unique look.

Standard Paint Colors

ARCTIC WHITE w/BROWN GLAZE w/MOCHA GLAZE w/NICKEL GLAZE	BEACH WHITE w/BROWN GLAZE w/MOCHA GLAZE w/NICKEL GLAZE	REPOSE GREY w/BROWN GLAZE w/MOCHA GLAZE w/NICKEL GLAZE
SIMPLY WHITE w/BROWN GLAZE w/MOCHA GLAZE w/NICKEL GLAZE	BALBOA MIST w/BROWN GLAZE w/MOCHA GLAZE w/NICKEL GLAZE	SEAGRASS w/BROWN GLAZE w/MOCHA GLAZE w/NICKEL GLAZE
MELTED BRIE w/BROWN GLAZE w/MOCHA GLAZE w/NICKEL GLAZE	PEBBLE GREY w/BROWN GLAZE w/MOCHA GLAZE w/NICKEL GLAZE	ARIA w/BROWN GLAZE w/MOCHA GLAZE w/NICKEL GLAZE
WINGS w/BROWN GLAZE w/MOCHA GLAZE w/NICKEL GLAZE	RAG & BONE w/BROWN GLAZE w/MOCHA GLAZE w/NICKEL GLAZE	NETWORK GREY w/BROWN GLAZE w/NICKEL GLAZE

MOON BAY w/BROWN GLAZE w/MOCHA GLAZE w/NICKEL GLAZE	MINERAL GREY w/BROWN GLAZE w/NICKEL GLAZE	BLUE ASH w/BROWN GLAZE w/NICKEL GLAZE
HIGH PARK w/BROWN GLAZE w/MOCHA GLAZE w/NICKEL GLAZE	BASIL w/BROWN GLAZE w/MOCHA GLAZE w/NICKEL GLAZE	BOTTLE GREEN w/BROWN GLAZE w/MOCHA GLAZE w/NICKEL GLAZE
MOSS GREEN w/BROWN GLAZE w/MOCHA GLAZE w/NICKEL GLAZE	PEPPER w/BROWN GLAZE w/MOCHA GLAZE w/NICKEL GLAZE	BLACK

Backs of doors are painted, but not glazed or distressed.
Hand-applied glazing and distressing are custom effects and will be slightly different on each application.
Due to the inevitable and natural movement of wood, paint finishes may show some cracking at joints.
This is not considered a defect.

Not all colors and finishes are available on all door styles. Printed and digital materials should never be used for color matching. We recommend ordering a sample door to see the best representation of your selected color, finish, and wood grain contrast and patterns on your selected door style, before ordering cabinetry. Sample doors are more accurate than any website, printed literature, or designer's color chips. See your designer for details.

Custom Paint Colors

Don't see what you want in our paint colors? Have your designer send us a paint swatch or a sample of the item you want to match, and our Color Masters will produce a custom paint color just for you. Then we'll produce a full-sized sample door in the style you choose so you can take it home and make sure you love it.

Ask to see the current Colour Couture selection – a designer-curated collection of trending complementary finishes.



Specialty Finishes



BROWN GLAZE MOCHA GLAZE NICKEL GLAZE

Glaze

Wood is painted or stained, then if desired, distressed. Glaze is hand-applied and rubbed away leaving color collected in crevices unique to each door style.



Linen Finishes

Primed and painted wood is lightly hand-brushed with Brown or Nickel glaze creating a linear, brushed look. Available on Maple or MDF with Standard or Low Sheen.



Vintage Finishes

An innovative blend of light glazing, rasping, rub-off, worm holes, stress cracks, dents, and smooth worn edges on any paint color on Maple. Sealed with a clear top coat. Low Sheen only.



Rubbed

Primed, painted wood is randomly sanded to reveal bare edges and high points, then sealed with a clear top coat. Add Glaze if available (no Linen, please). Always with Low Sheen.



Aged

Painted or stained wood is randomly dented with special tools to cause stress cracks, and sealed with a clear top coat.



Heritage

A combination of Rubbed and Aged detailing. Available on paints. Always with Low Sheen.



Caden door style in Maple with Basil and Aria paint.





Oliver door style in Maple with High Park paint.



Oliver door style in Maple with High Park and Black paint.



Shaker door style in Network Grey paint. Designer: Angela Goodall, Kitchen Choreography. Photo: Jason Hulet.



Stickley door style in Arctic White paint.



Rockford door style in Repose Grey paint with Brown Linen glaze. Designer: Angela Goodall, Kitchen Choreography. Photo: Jason Hulet.



Oliver door style in Maple with Seagrass paint and in Oak with Storm Grey stain. Also, AF003 Metal doors in Onyx with Low Iron Clear Tech Glass.



Mathis door style Quartersawn White Oak with Dune stain.

High Style, High Value

Eurotek

Our Eurotek Program is a cost-effective solution for achieving the look of wood doors in a quality, low maintenance alternative. You get the benefits of high-style wood aesthetics, in a high-value product.

The woodgrain simulation is created by permanently laminating printed Eurotek veneer to a durable door constructed of medium-density fiberboard (MDF). This

process eliminates expansion and contraction and color variances associated with real wood.

Eurotek not only has a consistent, authentic wood look, but you'll also enjoy the color-fast, durable finish of this smart product. It is beautiful, durable, and affordable. Feel proud and excited about your kitchen, bath, or living spaces, without breaking the bank.

Door Styles



CAPE MAY
5-PC drawer front
Shown in Grey Opal



CLERMONT
5-PC drawer front
Shown in Grey Mist



JAMESTOWN
5-PC drawer front
Shown in Dove White



LAKEHURST
5-PC drawer front
Shown in Bright White



Finishes



BRIGHT WHITE
CM C L



DOVE WHITE
J



WHITE CYPRESS
CM C



GREY OPAL
CM C



GREY MIST
CM C

Finish availability
by door style:
CM = Cape May
C = Clermont
J = Jamestown
L = Lakehurst

Not all colors and finishes are available on all door styles. Printed and digital materials should never be used for color matching. We recommend ordering a sample door to see the best representation of your selected color, finish, and wood grain contrast and patterns on your selected door style, before ordering cabinetry. Sample doors are more accurate than any website, printed literature, or designer's color chips. See your designer for details.

Jamestown door style in Dove White Eurotek. Designer: Kitchen & Bath Design + Construction Design Team. Photo: Chrissy Racho.



Evanston door style in Oak with Platinum Grey stain.



AF006 door style in Natural Auminum with Bronze Matte Tech Glass inserts, Piper door style in Charred Textured Melamine, and Archicrete Textured Melamine panels.

A Glint of Jewelry

Metal

Professional and commercial spaces do not hold the sole right to feature metal and glass in a kitchen. Expand your cabinetry design options by considering our versatile metal frames and glass for your central decor theme, or just sprinkled throughout your space.

The light and reflections inherent in glass and metal brighten spaces, granting a clean, polished environment, and can also make your kitchen look more spacious. Going heavier on the amount of metal will result in more of an industrial or commercial flair.

Can't quite go all in with metal and glass? No problem. Create the essence of your space with cabinetry you

love, then add in a little bling. Metal pairs well with all of our other door materials in both transitional and contemporary styles. Just add a couple of metal and glass doors where they make sense functionally or where they can complement your overall design style.

It's easy to pull together beautiful doors from our Metal Program. The metal frames vary in width from barely there to a strong showing and are available in five finishes: Brushed Stainless, Natural Aluminum, Gold, Graphite and Onyx. Every combination pairs well with our Tech Glass options. Clear, backpainted, and patterned glass can help you design a you-nique kitchen that isn't found anywhere else in the neighborhood.

Door Styles



AF006
Shown in Onyx with White Matte Backpainted Tech Glass
Backpainted Glass only; cannot be drilled for hardware



AF002
Shown in Gold with Clear Tech Glass



AF017
Shown in Brushed Stainless with Bronze Matte Backpainted Tech Glass



AF003
Shown in Graphite with Grey Clear Tech Glass

Backpainted Tech Glass should not be lit from behind.

Not all colors and finishes are available on all door styles. Printed and digital materials should never be used for color matching. We recommend ordering a sample door to see the best representation of your selected color, finish, and wood grain contrast and patterns on your selected door style, before ordering cabinetry. Sample doors are more accurate than any website, printed literature, or designer's color chips. See your designer for details.

Tech Glass

Pair Tech Glass with any of our door styles. Available in clear, backpainted and patterned styles, plus a variety of tints, Tech Glass can add moments of contemporary and industrial brilliance to your decor.



WHITE MATTE BACKPAINTED



SATIN



QUATTRO CARBON



MIST MATTE BACKPAINTED



CLEAR



BRONZE CLEAR

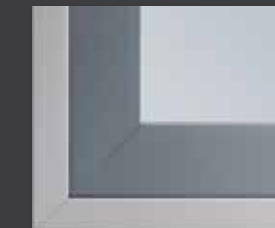

GREY CLEAR



WHITE GLOSS BACKPAINTED



LOW IRON SATIN



LINEA IVORY



MIST GLOSS BACKPAINTED

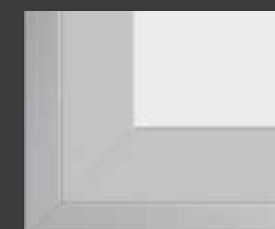

LOW IRON CLEAR

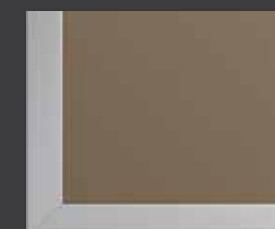

BRONZE MATTE BACKPAINTED

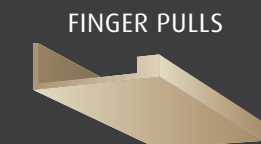

FINGER PULLS
We have wrap-around pulls available in every Metal finish. Use them on any of our doors!

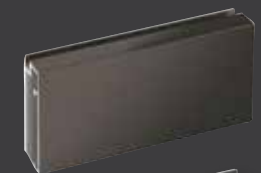

GRAPHITE



ONYX



GOLD



BRUSHED STAINLESS



NATURAL ALUMINUM

Show Off A Little!

Art Glass



Mullion Options

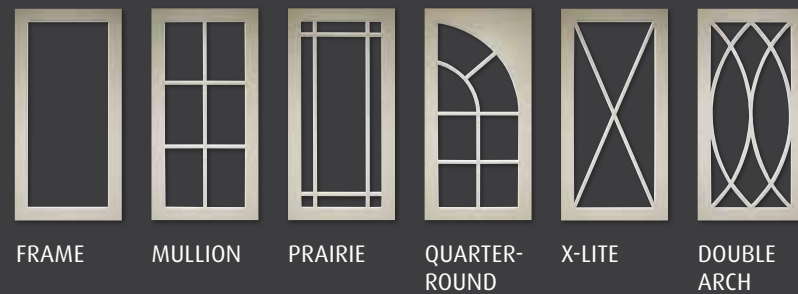

Leaded Glass Options



Leaded Glass options are not available with every style of Art Glass. Many patterns are fixed as shown and cannot be altered. Ask your designer for details.



Stickley door style in Rustic Alder with Natural stain and Lakeway door style with Blue Ash paint.



Accessories

The fun of designing a new kitchen kicks up a notch when you're choosing accessories. We offer components that display, hide, spin, pull out, illuminate, and organize.

The cooks in your family will appreciate how well we organize spices, pots and pans, and how we free-up counter space with dedicated storage for idle counter appliances.

When you entertain, LED lighting mellows the mood, Soft Close drawer glides cushion the noise, and built-in wine racks add a sophistication to the evening.

In the ultimate dream kitchen, everything has a place. The pantries arrange neatly, drawers stay organized, lazy Susans save time, trash bins hide, and the bi-fold, swing-out and flip-up doors are ... well, they're just cool.

Enjoy the process of working with your kitchen designer and then revel in your dream kitchen reality!

Accessories

Pull-out, Pull-down, Lift-up, Spin Around

- Kessebohmer Pull-out Trays
- Kessebohmer Pull-out Pantry Base Cabinets
- Kessebohmer Lemans Pull-outs in Blind Corner Highboards and Base Cabinets
- Chrome Pull-outs in a Blind Corner Base Cabinet
- Century Pull-out Organizer Base Cabinets
- Century Cookie Tray Pull-out Cabinet
- Century Pull-out Canister Organizer Base Cabinets
- Century Pull-out Knife Block Organizer Base Cabinet
- Narrow Spice Pull-outs
- Glideware Pots & Pans Pull-out
- Kessebohmer Sink Caddy
- Mixer Lift-Up Base Cabinet
- Kessebohmer Larder Tall Cabinets
- Kessebohmer Pantry Tall Cabinets
- Kessebohmer Dispensa Pantry Tall Cabinet
- Century Pantry Pull-out Tall Cabinet
- Century Vanity Hutch Pull-out Organizer



Century Hutch Pull-out Organizer Vanity Cabinets



Kessebohmer Twister Lazy Susans



Wood, Shelf-mounted Lazy Susans



Kessebohmer Chrome Rail Lazy Susans

Lazy Susans

- Kessebohmer Twister
- Wood, Shelf-mounted
- Kessebohmer Chrome Rail



Kessebohmer Pull-outs



Kessebohmer Pantry Pull-out Base Cabinets



Kessebohmer Lemans Pull-outs for Blind Corner Highboard and Base Cabinets



Kessebohmer Larder Tall Cabinets



Kessebohmer Waste Basket Base Cabinets



Hanging Trash Bins Base Cabinets



Revolving Recycle Bins

Clean & Green

- Kessebohmer Waste Basket
- Century Waste Bin
- Hanging Trash Bin
- Single Trash Bin
- Double Trash Bin
- Recycle Bin
- Revolving Recycle Bins
- Vanity Trash Bin



Kessebohmer Dispensa Pantry Tall Cabinets



Century Pantry Pull-out Tall Cabinets



Century Organizer Pull-out Base Cabinets



Century Cookie Tray Pull-out Base Cabinets



Glideware Pot-and-Pan Rack



Kessebohmer Sink Caddy



Laundry: Tall Hampers (shown), Base Hampers, Vanity Hampers, Hanging Hampers



Cool Doors: Swing-up, Bi-fold, Flip-up, Metal Tambour Roll-up (shown), and Pocket

Soft-Close Drawer Systems

- Wood Dovetail Drawers w/Soft Close
- Wood Dovetail Pull-outs w/Soft Close
- Metal Drawers w/Soft Close
- Metal Drawers w/Soft Close and Touch-to-Open *Go hardware-free!*
- Metal Pull-outs w/Soft Close



Wood Dovetail Drawers w/Soft Close



Wood Dovetail Pull-outs w/Soft Close



Metal Drawers w/Soft Close



Metal Pull-outs w/Soft Close

Accessories

Drawer Organization

- Pull-out Trays Above Drawers
- 2-tier Top and Pots & Pans Drawers
- Finition MOVE Boxes
- Finition Pegboard System
- Stainless Steel Dividers
- Dovetail Cutlery Dividers
- K-Cup Holder
- Finition Tray System with Accessories
- Blum Dividers for Top Metal Drawers
- Blum Dividers for Deep Metal Drawers
- Wood Knife Block
- Blum Plastic and Foil Wrap Dispensers
- Convertible Plate Holder
- Bread Bin
- Charging Drawer
- Non-slip Mat



Finition MOVE Boxes



Finition Tray System with Accessories
(Spice Jars are no longer available.)



Finition Pegboard System



Blum Metal Drawer Dividers - Top Drawers



Dovetail Cutlery Insert



Blum Metal Drawer Divider - Deep Drawers



K Cup Drawer Insert



Convertible Plate Holder



Open & Floating Wall Shelves



LED Lighting and Glass Shelves



Wine Accessories



Wood Stemware Rack

Shelving

- Glass Shelves
- Open/Floating Shelves

Aurora Lighting System

- Puck Lights
- Bar Lights
- Ribbon Lights



Wine Cubes

For Wine Lovers

- Chrome Stemware Rack
- Chrome Bottle Rack
- Wood Stemware Rack
- Lattice Wine Cabinet
- Wine Cubes Cabinets



Wainscoting



Decorative Brackets, Corbels, Feet, Legs and Posts



Decorative Valances

Finishing Touches

- Touch Latches
- Wainscoting
- Walk-through Pantry Doors
- Mouldings and Trim
- Decorative Brackets, Corbels, Feet, Legs and Posts
- Decorative Valances
- Veneer Wood Tops



Spice Drawers



Letter File

Spice it Up

- Spice Rack, Door-mounted
- Spice Drawer Cabinets
- Spice Pull-out Cabinets
- Narrow Spice Pull-outs
- Spice Drawer Insert
- Orga Line Spice Drawer Insert

Home Work

- Letter Cubbies
- Desk Cabinets
- Hanging Drawers
- File Cabinets
- Trash Bin Cabinets



Range Hoods



Appliance Garages



Island Cabinets with Metal Feet

Leftovers

- Range Hoods
- Appliance Garages
- Wicker Basket Cabinets
- Vegetable Drawer Cabinets
- Tray Divider Cabinets
- Island Cabinets with Feet

Full Access Advantages

FULL ACCESS CONSTRUCTION

True Full Overlay: doors cover entire face of the cabinet

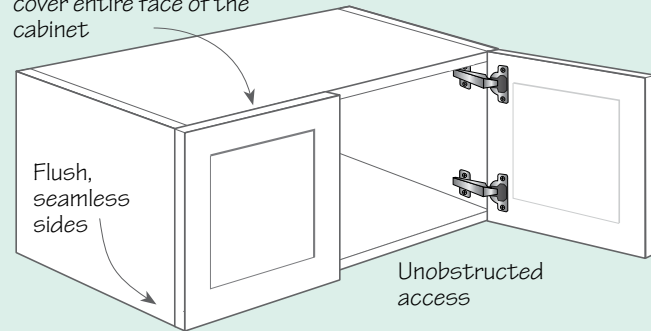

FRAMED CONSTRUCTION

Reveal of the frame shows around the door

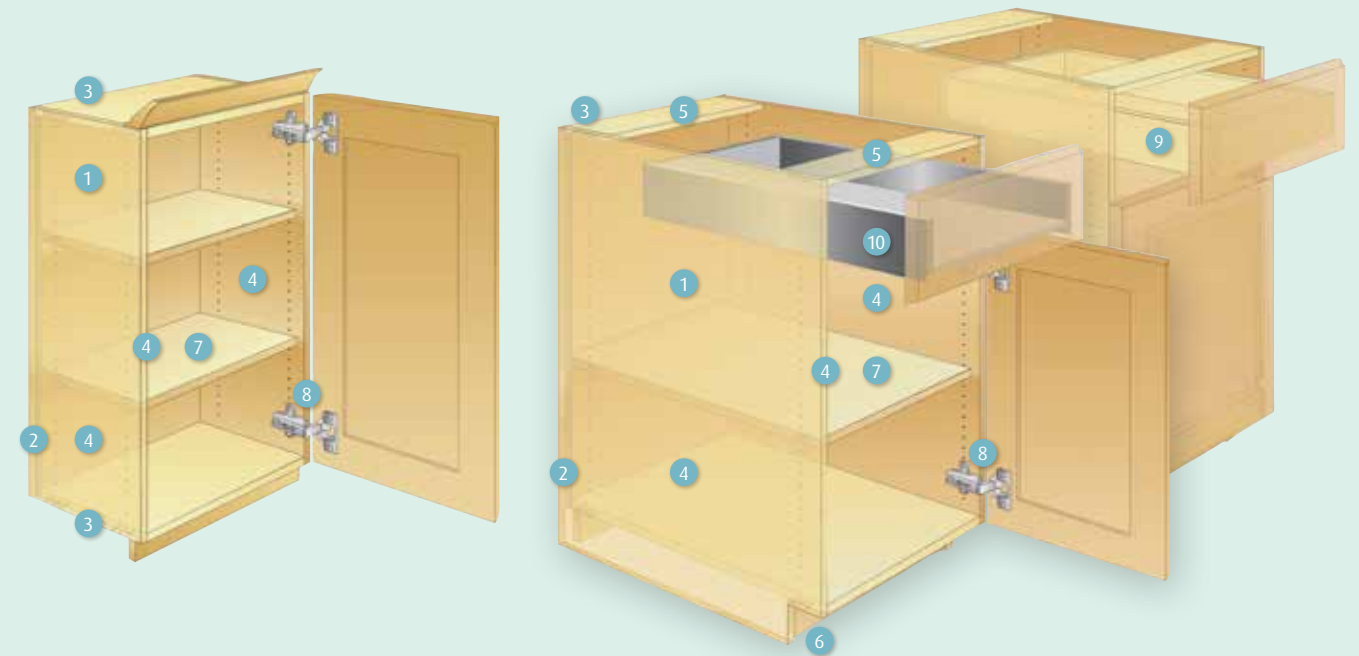
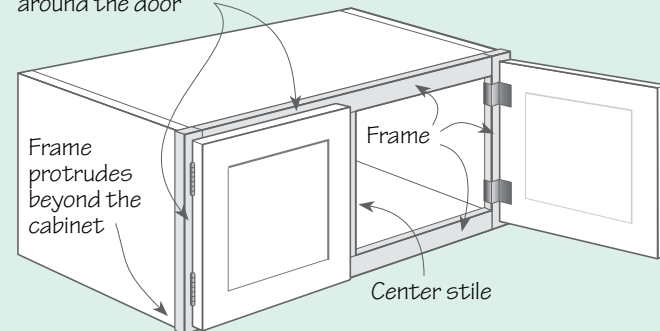

FULL-ACCESS DESIGN

UNOBSTRUCTED ACCESS

A full-access, or frameless, cabinet has no knuckle-nicking frame or center stile to impede access to stored items. Cleaning is easier too.

THE CLEANEST LOOK

Instead of a frame sticking out beyond the box, cabinet sides are seamless and flush.

Doors cover the entire face of the cabinet. It's called *true full-overlay*, and it's key to a clean, modern look.

15% MORE STORAGE SPACE!

Best of all, with no frame stealing space from cabinet interiors and drawers, full-access cabinets have up to *15% more storage space!* Go ahead and buy those large plates you've had your eye on.

LEADING-EDGE FASHION, FUNCTION, AND FIT

SO MUCH TO CHOOSE FROM!

We offer a comprehensive selection of today's most-popular styles, finishes and materials from high-gloss to UltraMatte: acrylic, textured melamine, thermofoil, Eurotek, metal, glass, and of course, classic wood. No worries! Your professional kitchen designer will help you choose.

FINE FURNITURE FINISHES

If wood is your style, we offer Oak, Maple, Cherry, Rustic Cherry, Alder, Rustic Alder, Red Birch, Walnut, and Quartersawn White Oak. Select from our palette of stains, paints, custom paints, glazes, Linen and distressed artisan finishes. All hand-crafted with our 14-step finish process.

CUSTOM STORAGE OPTIONS

Outfit your kitchen with accessories for the way you live: pantries, drawer organizers, spice and wine racks, waste and recycle bins... And, your home doesn't stop at the kitchen. Explore storage solutions for the bathroom, home office, playroom, and entertainment centers.

EXPAND YOUR BUDGET

We will custom-modify a cabinet's width, height, and depth, to 1/16" inch for no charge.* Finished Ends are no charge, as are Finished Interiors.

*up to the next standard size cabinet

CONFIDENCE AND ASSURANCE

TRY BEFORE YOU BUY

With our Sample Program we can ship full-size samples of your favorite door styles and finishes so you can live with them in your home before you decide.

KINDLY MADE, IN AMERICA

Our cabinetry is built in the heart of the country's furniture manufacturing industry, from domestically- and globally-sourced components. We comply with strict CARB II standards.

100-YEAR LIMITED WARRANTY

PERFORMANCE CONSTRUCTION

ARCHITECTURAL SPECIFICATIONS

- Cabinet box** is manufactured with 5/8"-thick, environmentally-friendly, EPP-certified Engineered Furniture Core or All-Plywood panels; dowel-and-glue joinery.
- Back panel** is 5/8"-thick, fully-captured, machine-fitted and provides structural integrity and options for installation screws.
- Top, bottom, and sides** are flush for easier installation, easier application of footed mouldings and light rails, and a furniture-like appearance.
- Finish** for top, bottom and sides – inside and out – is White, Grey, or Neutral Woodgrain moisture-resistant melamine. Exposed edges (except inside edges of top stretchers) are edgebanded. Maximum coverage protects against moisture.
- Full-width stretchers**, front and rear, provide solid support and a mounting surface for countertops.
- Toe-space blocking**, front and rear, for stability.
- Shelves** are 3/4"-thick, full-depth, edgebanded, adjustable, and supported with metal shelf clips.
- Hinges** are durable steel, fully-concealed, clip-on/off, self-closing, 110°, 6-way-adjustable (for precision door alignment), with a lifetime manufacturer's warranty and soft-close operation.
- Wood Dovetail Drawers and Pull-outs with Soft Close**
The drawer box has 5/8"-thick, solid wood on all four sides, dovetail joinery at each corner, and 1/4"-thick, fully-captured bottom, all in natural-finish Birch (standard) or Walnut (upgrade). Soft Close glides allow smooth and silent closing. Glides are a full-extension, tandem, undermount system with a 100-lb. static / 90-lb. dynamic-load rating. Glides have a manufacturer's lifetime warranty.
- Metal Drawers and Pull-outs with Soft Close**
Blum Legrabox. Sides are fingerprint-less metal with a stainless steel look. Bottom and back are 5/8"-thick grey melamine. Soft Close glides are a built-in, full-extension, undermount system with 125-lb. static / 110-lb. dynamic-load rating. Glides have a manufacturer's lifetime warranty.

Finished Ends, Finished Interiors, and Panels are color-coordinated with the door finish. Front edges have matching wood or coordinating PVC edgebanding.

Wood Dovetail Drawers are standard on cabinets with all door styles except UltraLux.

10. Metal Drawers and Pull-outs with Soft Close

Blum Legrabox. Sides are fingerprint-less metal with a stainless steel look. Bottom and back are 5/8"-thick grey melamine. Soft Close glides are a built-in, full-extension, undermount system with 125-lb. static / 110-lb. dynamic-load rating. Glides have a manufacturer's lifetime warranty.

Metal Drawers are standard on cabinets with UltraLux door styles and available as an upgrade with all other door styles.

Touch-to-Open

An upgrade to the Metal Drawer. Open the drawer by pressing on the drawer front; eliminate the need for decorative hardware.

CABINET CARE



Your cabinetry is designed to withstand normal, daily household activities and should be treated like fine furniture. Follow these simple recommendations to care for your cabinetry:

WOOD AND EUROTEK CABINETS

The tough, catalyzed varnish protecting your cabinetry should resist foods, beverages, and household agents normally found in today's homes.

WOOD, MELAMINE, METAL, THERMOFOIL, AND EUROTEK CABINETS

Clean cabinet exteriors and interiors using a soft, damp cloth (not a paper towel) and a mild, non-detergent soap (we recommend 100 parts water and 1 part liquid dish soap). Dry immediately. Do not use abrasive soap pads, abrasive cleansers, steel wool, bottled spray cleaners, solvent-based cleaners, or cleaners containing bleach. Wax or polish is not necessary and is not recommended. Excessive moisture can damage the finish. Do not spray cleaner directly on cabinet or allow moisture to seep into seams or joints. Do not leave damp cloths draped over cabinet doors or drawers.

THERMOFOIL CABINETS

Thermofolds, while very durable, can be damaged by excessive heat. Properly-installed Heat Shields protect cabinets adjacent to ovens, ranges, and dishwashers. As a precaution, open doors and drawers away from an oven during high-temperature, self-cleaning cycles. Also, pull countertop appliances, such as toasters, ovens, grills, or coffee makers, out from under the cabinetry before use. Damage caused by excessive heat is not covered under warranty.

ULTRALUX CABINETS

The high-gloss surfaces of UltraLux are covered with a protective film from the manufacturer. Remove the film after cabinet installation. To clean, use a micro-fiber cloth or other very soft cloth with a non-abrasive soap or detergent. Do not use paper towels, brushes, scourers, or scrapers. Avoid harsh household cleaners and abrasives such as acetone, chloroform, benzene, ammonia,

thinners, caustic soda, toluene, xylene, dichloromethane, amyl acetate, glacial acetic acid, butyl alcohol, butyl acetate, Cellosolve, cresols/phenols, ethyl acetate, chlorinated solvents, halogenated solvents, methyl alcohol, methyl ethyl ketone, and sink and toilet bowl cleaners. Safely remove any adhesive near the edges with mineral spirits.

REPAIR KIT

Small nicks and scratches that occur during daily use can be repaired using the products in the Touch-up Kit. Follow all instructions and keep all products out of reach of children.

MARKER: Capillary markers are ready to use, just remove the cap. Valve Markers require shaking to mix the contents. Depress the valve to start the flow, careful not to over-flood the felt tip.

FILL STICK: Fill damages with the stick and gently remove excess material by rubbing with a clean, dry, lint-free cloth.

ultracraft® 100-Year Limited Warranty (Residential Purchaser)

MasterBrand Cabinets LLC ("We" or "Us") extends the following limited 100-year warranty ("Limited Warranty") to the first Residential Purchaser ("You" or "Your") of a cabinet manufactured by Us (each, a "Product"). This Limited Warranty is only applicable to Products sold to the first Residential Purchaser and used in the applications described below within the United States, Canada, and/or Mexico. Except as allowed below or by applicable law, You may not assign or transfer this Limited Warranty.

WHO IS A RESIDENTIAL PURCHASER? Under this Limited Warranty, a "Residential Purchaser" means any of the following:

- a person who purchases and installs the Product in a dwelling that is owned and used by that person as a primary or secondary home;
- any person or business such as a builder, contractor or developer that purchases and installs the Product in a newly constructed or remodeled dwelling that will be used by the initial owner/purchaser of that dwelling as a primary or secondary home. In such situation, this Limited Warranty may be assigned to the initial owner/purchaser who uses the dwelling as a primary or secondary home. In such circumstances, this Limited Warranty may be assigned to the initial owner/purchaser who uses the dwelling as a primary or secondary home. Under this Limited Warranty, a primary or secondary home does not include rental property, or homes used for vacation rental properties, even on a part-time basis (e.g., Airbnb, VRBO, etc.). This Limited Warranty does not apply to landlords, leasing companies or other commercial purchasers (See Commercial Warranty); or
- a consumer subject to the Quebec Consumer Protection Act.

WHAT DOES THIS LIMITED WARRANTY COVER? Subject to the exclusions and limitations set forth in this Limited Warranty, We warrant to You that each Product will be free from defects in material and workmanship, under normal use and maintenance, for the applicable warranty period stated below. This warranty gives You specific legal rights, and You may have other rights which vary from State to State or Province to Province.

WHAT IS THE WARRANTY PERIOD APPLICABLE TO RESIDENTIAL PURCHASERS? The warranty period for Your Product (excluding certain components discussed in the following paragraph) begins on the date the Product was purchased, whether purchased by You or by a third party on Your behalf. Your warranty is only valid if you use the dwelling as your primary or secondary home and does not extend to future owners if the property is sold.

Notwithstanding the preceding paragraph, the warranty periods applicable to the following Product components that were not originally manufactured by Us are as follows:

- Vent Hoods, Blowers, and components: 1 year from the date of original purchase
- Lighting, Electronic, and Powered components: 2 years from the date of original purchase.
- Decorative Hardware: 1 year from the date of original purchase.

DISCLAIMER OF OTHER WARRANTIES: IF YOU ARE A CONSUMER SUBJECT TO THE QUEBEC CONSUMER PROTECTION ACT, THE EXCLUSION OF WARRANTIES CONTAINED IN THE IMMEDIATELY FOLLOWING PARAGRAPH DO NOT LIMIT YOUR RIGHTS AND REMEDIES UNDER SUCH ACT, INCLUDING THE RIGHT TO MAKE A CLAIM UNDER ANY OF THE STATUTORY WARRANTIES PROVIDED UNDER SECTIONS 34 TO 54 OF SUCH ACT. CERTAIN OTHER STATES OR PROVINCES DO NOT ALLOW LIMITATIONS ON HOW LONG AN IMPLIED WARRANTY LASTS, SO THE BELOW LIMITATION MAY NOT APPLY TO YOU.

THIS LIMITED WARRANTY IS OUR SOLE AND EXCLUSIVE WARRANTY WITH RESPECT TO THE PRODUCTS. ALL IMPLIED WARRANTIES ARE STRICTLY LIMITED TO THE DURATION OF THE LIMITED WARRANTY APPLICABLE TO THE PRODUCT AS STATED ABOVE, INCLUDING BUT NOT LIMITED TO, ANY WARRANTY OF MERCHANTABILITY OR OF FITNESS FOR A PARTICULAR PURPOSE.

WHAT THIS LIMITED WARRANTY DOES NOT COVER: The Limited Warranty does not apply to any Product:

- (1) installed or used outdoors;
- (2) used for purposes for which it is not designed or intended by Us;
- (3) which has been subjected to misuse, vandalism, abuse, negligence, accident, or unauthorized modifications;
- (4) which has been improperly stored (if the Product must be stored, it should be covered and stored in a humidity and temperature controlled environment, away from direct sunlight);
- (5) which has been improperly installed, cleaned, or maintained (for more information regarding the proper use and care of the Product, please consult the applicable Use and Care Instructions that accompanied the Product or that can be found at www.masterbrand.com/care-and-cleaning);
- (6) which has been subjected to improper temperature, moisture and/or humidity extremes (temperature outside the range of 50-85°F (10-29°C) and humidity outside the range of 30-55% are considered extreme);
- (7) damaged by fire, flood, acts of God, or other external causes beyond our control;
- (8) varying in color and characteristics due to age, sunlight, smoke, or other environmental conditions;
- (9) exhibiting any effects on the color and/or integrity of the finish or appearance due to the use of abrasive cleaners, cleaners that contain chlorine, acidic cleaners, scuffing sponges or steel wool;
- (10) which has been subjected to weight in excess of 15 pounds for square foot for shelves and all load bearing surfaces;
- (11) which has been purchased or sold as salvage goods or products by any individual or entity;
- (12) exhibiting warping that occurs after the first 365 days from the date of purchase;
- (13) which has been subjected to direct contact with a liquid for an unreasonable period of time (i.e., bath or kitchen sink water not being wiped off when direct contact occurs);
- (14) which has been subjected to excessive heat and/or steam;
- (15) for which You have received a full refund from any person or entity other than Us; and/or
- (16) exhibiting normal wear and tear.

In addition, natural woods may vary in color and characteristics and exhibit subtle changes as they age. For example, painted doors, drawer fronts, and face frames may eventually have visible cracking around the joint area, and cabinet colors may darken or lighten over time. Further, natural wood and finishes will have "character" spots (knots, burl, blemish, flecking, etc.) which could impact hardware placement. Knots, if they appear, will be sound and closed. At certain angles, light may be visible through a knot. Flecking, a visual characteristic that may appear based on the cellular composition of wood when cut, is based on the natural and unpredictable characteristics of raw material. These variations and features are considered to be the nature of the material in relation to their environmental exposure and are not covered under this Limited Warranty.

All solid and composite wood used in our Product is processed to a moisture content that is resistant to insect infestation. The manufacturing process for veneer and engineered wood products is followed to effectively eliminate insects from manufactured panels and structural composite lumber products. Please note that it is possible for infestation to occur after manufacturing whether in storage or after installation due to environmental conditions. As set forth above, this Limited Warranty does not cover environmental conditions, such as excessive humidity during storage or the infestation of powder post beetles, termites, etc., once the product leaves our facility. In any new construction or remodel, a home may be exposed to the elements, and it is the homeowner's responsibility to take preventative measures to avoid infestation subsequent to delivery of our Product.

SOLE AND EXCLUSIVE REMEDY: In the event of a defect in the workmanship or materials of a Product or Product component occurring during the warranty period described above, We will, at our option, repair or replace any defective Product or Product component. If We determine, at our sole discretion, it is not commercially feasible to repair or replace a defective Product or Product component, We may refund the original price paid by You for the defective Product or Product component, or provide a credit towards a similar type of product sold by Us. The foregoing are Your sole and exclusive remedies for any Product defect or non-conformity. By way of example but not limitation, the following costs and expenses are not covered by this Limited Warranty: (1) labor costs for the original installation, removal, or reinstallation of the Product, or defective part thereof; (2) labor costs or material charges for the removal, reinstallation, repainting, refinishing or replacement of any other items or building materials which must be removed, replaced, reinstalled, or refinished in order to repair or replace the defective Product or component. For example, costs associated with the following will not be reimbursed: counters, sinks, tiles, flooring, accessories, appliances or plumbing fixtures. When a timely claim for warpage, joint separation or wood growth is submitted, We may, at our option and after inspection, defer action for up to 12 months to allow the Product to acclimate to the installed environment. Additional information regarding warping can be found at <https://www.masterbrand.com/humidification>. Further, We reserve the right to modify or alter any Product design, specifications or materials without obligation to make similar changes to Products previously manufactured or sold by Us.

The repair or replacement remedies offered by Us under this Limited Warranty are contingent on the current Product offerings of styles and construction options within our Product line at the time a warranty claim is made by You. If a valid warranty claim is filed for an obsolete Product, We reserve the right, at our sole option, to honor its repair or replacement obligations under this Limited Warranty by either: (1) replacing the affected Product or component with a new Product or component of the same or approximate style or color from our current Product line or offerings; or (2) replacing the affected Product or component to achieve a uniform appearance with a similar or comparable product style or approximate color of the originally purchased style. If a Product or components are replaced or repaired, We cannot guarantee an exact match with the finish or appearance of other products or fixtures installed at Your dwelling. This is due to changes that may occur during the Products' natural aging process, affecting its color and/or grain.

EXPECTATIONS OF PURCHASER: We expect that You will promptly inspect all Product and promptly inform Us of any defects in the workmanship or materials of a Product or Product component. We also expect that You will cooperate with and accommodate all reasonable requests by Us to investigate and evaluate any claim made pursuant to this Limited Warranty, including requests to allow Us to inspect and/or test the Product.

LIMITATION OF LIABILITY: If You are a consumer subject to the Quebec Consumer Protection Act, the limitations of liability contained in the immediately following paragraph do not release Us from the consequences of our own actions or the actions of our representatives. Certain other States and Provinces do not allow the exclusion or limitation of incidental or consequential damages, so the below limitation or exclusion may not apply to You.

The remedies described above are Your sole and exclusive remedies and our entire liability for any breach of this Limited Warranty. Our total liability shall under no circumstances exceed the actual amount paid by You for the defective product. Further, We shall not under any circumstances be liable for any consequential, indirect, incidental, special or punitive damages or losses (including but not limited to lost profits and alleged damages for delay, inconvenience, or emotional distress), even if this Limited Warranty is deemed to have failed of its essential purpose.

HOW DO YOU OBTAIN WARRANTY SERVICE? This Limited Warranty can also be found online at www.ultracraft.com/project-planning/warranty/ [or/and] in the documentation that accompanied Your Product. To obtain more information regarding the Product or to make a claim under this Limited Warranty, contact one of our authorized dealers or distributors, who will arrange for inspection of the Product. A dated sales receipt as proof of purchase is required to obtain benefits from this Limited Warranty. If you have difficulty obtaining assistance, please write to:

MasterBrand Cabinets LLC; Attn: Consumer Affairs, One MasterBrand Cabinets Drive, Jasper, IN 47546



Part of the
MasterBrand®
Family

©2025 UltraCraft Cabinetry



Printed 2/24/25 PDF Updated 2/24/25

UltraCraft Advantages

- Hundreds of doors in every popular material, finish, and style from traditional to ultra-modern
- Soft Close Drawers and Doors
- First-class Wood Dovetail and Metal Drawer systems
- Free size modifications for most cabinets; ask your designer for details
- Designer colors and modern Low Sheen finish at no upcharge
- Custom paint colors
- Popular paint, glaze, linen, and distressed finishes at low upcharges
- All-Plywood or Engineered Furniture Core construction
- Full-Access construction means more storage, easy-to-clean, and precise alignment
- Full-depth, adjustable shelves
- Made in America from domestically- and globally-sourced components
- 100-year Limited Warranty

Front Cover – Mathis and Marshall door styles in Quartersawn White Oak with Dune stain.

Back Cover – Oliver door style in Maple with High Park and Black paint.

Printed and digital images should not be used for color matching.

ultracraft®

800.803.2315

www.ultracraft.com